

## Android Application Based Mishap Identification and Warning System

Sumit Jambhulkar<sup>1</sup>, Aditya Vikram<sup>2</sup>, Sukhbani Kaur Viridi<sup>3</sup>, Priyank Sharma<sup>4</sup>,  
Khushhali Goel<sup>5</sup> and Gaurav Verma<sup>6</sup>

<sup>1,2,3</sup>*M.Tech. Scholar, <sup>5</sup>B.Tech Scholar, <sup>6</sup>Assistant Professor*  
*Electronics & Communication Department,*

*JIIT, Sector-62, Noida (U.P.)-India*

<sup>4</sup>*Embedded Software Engineer@VVDN Tech. Pvt. Ltd*

### Abstract

*Speed is one of the key reasons for accident in vehicles. These over speed accidents could be avoided if emergency services could be able to get the information and take necessary actions in time. Now a day it is very hard to imagine our daily life without transportation. Every invention has some limitation and so with the transportation. With the increase in the population the numbers of vehicles also increase on roads and highways to meet the necessity of travelling. And hence with the increase in vehicles, traffic jams and accidents are also increasing. So we need to develop a system which can help the public in such situations and can reduce the risk of mishap. Today, remote development has tilted the chances for achievement more than ever. This paper insight about mishap of car crisis ready circumstance. In this we are attempting to program a GPS/GSM module fusing an accelerometer to report events of mishap naturally by means of the GSM correspondence stage (utilizing SMS informing) to the closest organizations, for example, doctor's facilities, police headquarters, fire administrations et cetera, giving the definite position of the point where the accident had happened. With the help of this approach we will be able to provide an early response and relief to victims and reduce the risk of life loss due to accident.*

**Keywords:** *GPS, GSM, AT commands, ARM7 microcontrollers, Android Studio Interface*

### 1. Introduction

High speed in vehicles is the basic and major cause of accidents and the time between the occurrence of a mishap and arrival of emergency services is the only indicator of efficient survival rate. To check this issue automatic mishap identification and warning frameworks are being installed in vehicles. The major issue with these systems is they are not available for all types of vehicles and are confined to some due to their unaffordability. But as we have encountered the large and growing base of smart phones which are affordable as well as easy to access and handle, can provide a significant opportunity for creation of such devices making them a contrasting option to in-vehicles mischance recognition and reporting framework. Since Smartphones are preloaded with various sensors which can sense, supervise and manage different physical attributes, can be helpful to monitor any mishap as per their calibrated program for the same. Further that information can easily be transferred to emergency services in no time. Thus with this autonomous effective approach can extensively reduce traffic fatalities. This is the major goal of project to provide such system which is affordable as well as handy to all range of people and create a marginal difference in the aspect of safe driving.

## 2. Related Work

A principal cause for the occurrence of mishaps is speed which was mentioned by Md. Syedul Amin *et al.* [1]. The soul reason for the proposal of this paper is to point out the implementation capabilities of GPS receiver which can extract the vehicle location and also to detect the accident by monitoring the acceleration faced by the vehicles which undergo heavy change while this. Location, speed and the time are the prime content of the information along with the contact numbers of relative of victim which is sent as a GPRS data to alert rescue services. Salas K Jose *et al.* gives the enhanced execution of the innovation to turn the chances for accomplishment to spare lives more than ever [2]. Various programed modules like GPS/GSM module incorporated with an accelerometer is there to report the occurrences of an accident automatically. The whole system is based on ARM 7(LPC 2378), GPS Module MR87, MMA7660FC accelerometer and SIM 900 GSM module. One of the vehicular checking and following framework in light of ARM which utilizes GSM and GPS innovation is given in a paper by Prof. V.R. Kapur *et al.* where he uses ARM7 TDMI-S core processor LPC2148 [3]. Zhang Wen *et al.* gives a remarkable idea vehicle tracking system which is based on ARM microprocessor with GSMTC35 and GPSLR9574 in his paper [4]. Peng Chen *et al.* give the concept of intelligent vehicle monitoring system based on GPS, GSM and Geographic Information System (GIS) using the concept of TCP/IP and UDP communication protocol for the transmission of data between server and client [5]. An e-NOTIFY framework which permits speedy conclusion and location of car crashes thus reducing the time for the help and assistance response is given in a paper by Manuel Fogue *et al.* [6]. This system avails detailed information regarding exact time, location, type of vehicle, number of passengers and their conditions, point of impact and exact speed of vehicle after accident.

## 3. Hardware Implementation

1. The open source processing stage in view of Atmega328 which can speak with USB give us a striking instrument called Arduino for appearing well and good and control numerous physical parameter than a desktop PC. It incorporates a serial screen which profits straightforward printed information to be exchanged. The beneficiary and the transmitter on the board (Figure 1) will indicate the transfer of data via USB using a Light Emitting Diode. Uno's have digital pins which allows the software serial library for serial communication through any of them. The Arduino Uno installed with Atmega328 on it accompanies a boot-loader that give a client to transfer and also overhaul new codes to it without the utilization of any outside equipment software engineer. It imparts utilizing the real STK500 convention.

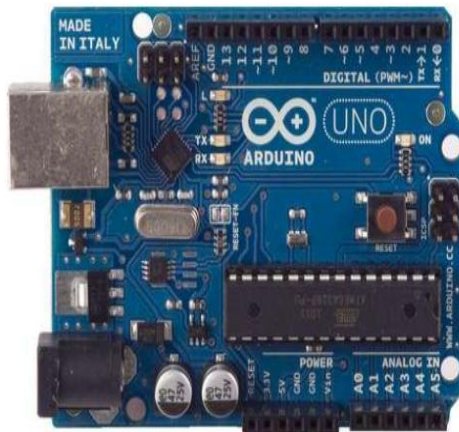
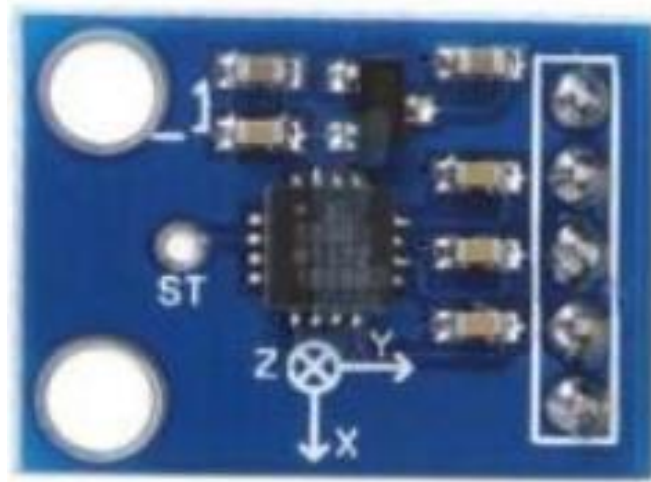

Figure 1. Arduino Board

2. A thin, small, low powered signal conditioned voltage output with complete three axis accelerometer which can measure the acceleration is the ADXL335 module (Figure 2). This device can measure the acceleration with a minimal full-range in spite of using additional temperature compensation circuit. This type of innovative design techniques satisfies the high enactment with non-monotonic behavior.



**Figure 2. ADXL335 Accelerometer**

3. A small GPS module S1315RL is designed for large range of OEM products. With this module you have a fast and easy interface with minimal risk. It comes in a compact surface mount package (Figure 3). Its high performance search engine make it capable to test 8,00,000 time-frequency within a second making it leading industry ready signal acquisition and TTF speed module. This module also has its own SAW filter and LNA. S1315RL module can do all necessary satellite signal acquisition and tracking, data demodulation and varied navigation solution autonomously.



**Figure 3. S1315RL GPS Module**

4. SIM900 module is a type GPS/GPRS engine that operates on frequencies like GSM850MHz, EGSM900MHz, DCS 1800MHz etc. It has a GPRS class8/10 multi-slot features whose RF part is capable to convert RF spectrum to baseband and vice versa. It uses a 0.18  $\mu\text{m}$  mixed signal CMOS technology that allows a huge integration with low power consumption. Solutions to the wireless Quad-band telephone handset and data

modem is provided by SC6600D ensuring to the EGSM900, GSM850 and DCS 1800 with the help of its 32MB memories.



**Figure 4. SIM900 GSM/GPRS Module**

This gadget controls the GSM motor by sending AT Command by means of its serial interface.

#### **4. Software Implementation**

The product used to build up the framework depended on Arduino IDE and Eclipse IDE. Arduino is a cross-stage IDE that works in simultaneousness with an Arduino UNO keeping in mind the end goal to compose, incorporate and transfer code to the board. The general dialects characterized for Arduino are C and C++. The project incorporates a rich gathering of inherent libraries, for example, EEPROM, GSM, Servo, TFT, Wi-Fi, and so forth. Besides we have Eclipse which is a stage intended for building coordinated web application improvement which is controlled by gives a typical client interface (UI) model for working with apparatuses. The Eclipse stage gives clients a typical approach to work with the instruments, and give incorporated administration of the assets they make with the modules. This stage deals with the many-sided quality of various runtime situations, for example, diverse working frameworks or distinctive server situations.

#### **5. Proposed System Description**

This anticipate proposes to use the capacity of a GPS collector to screen the rate of a vehicle and sense mishap taking into account checked speed and sends mischance area to an Alert and save focus. The GPS alongside the accelerometer will screen rate of the vehicle. At whatever point the pace will go underneath the predetermined edge level quickly, it will accept that a mishap has happened. The framework will then transmit the mischance area obtained from the GPS alongside the time and the velocity by misusing the GSM system. This will help to achieve the salvage administration in time and spare human lives. The Arduino Uno is a microcontroller board depends on Atmega328. The accelerometer is utilized to identify the speeding up. If there should arise an occurrence of mischance a huge estimation of increasing speed is gotten because of sudden change in the velocity, yet when the state of breaking comes it is to a great degree troublesome. So a caution is additionally given. It will draw out for 30 seconds. Still if the driver does not press the reset catch, then it will translate as a genuine mishap. It prompts the

microcontroller to conjure the GPS module. Worldwide Position System (GPS) gives area and time data in all climate conditions, anyplace on or close to the Earth. GPS collector S1315RL module is utilized that has dynamic patch reception apparatus. The GSM (SIM900) module uses the GSM system to send the area of the mishap. This module can be sorted out by the microcontroller through an arrangement of AT Commands. An Android constructed application (ANDROID APP) is developed so that it could get the exact location of the mishap based on Google maps which use to be pre-installed in smartphones. This working can be easily be understood by the following block diagram (Figure 5).

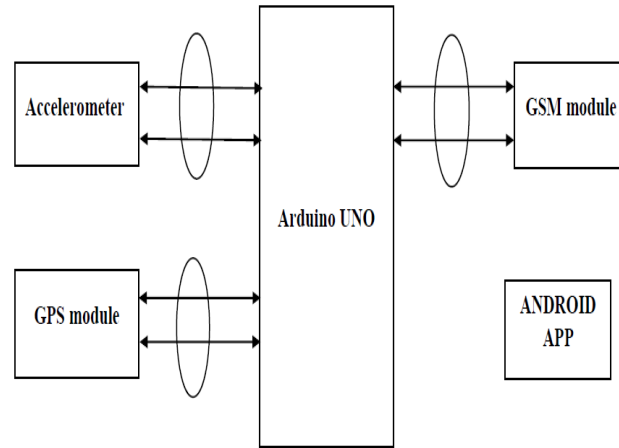

**Figure 5. Block Diagram**

## 6. Results and Discussions

### 6.1. The Hardware Connection of the Proposed System (Figure 6)

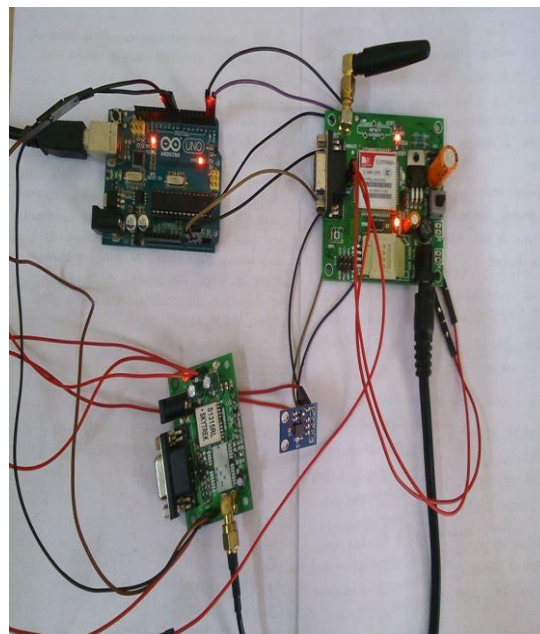

**Figure 6. Hardware Connection**

### 6.2. The Accelerometer Senses the Change and GPS Location is Sent Via GSM Module (Figure 7)

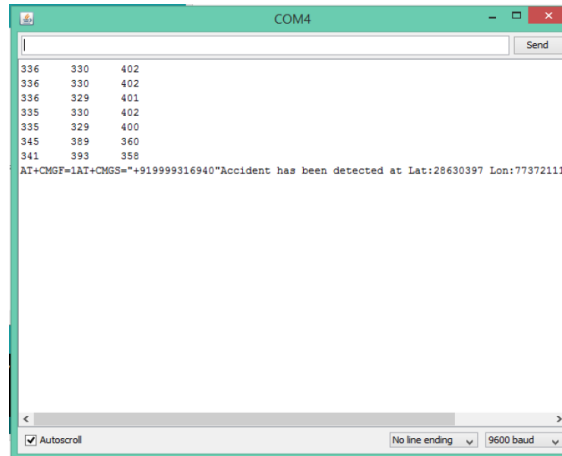

Figure 7. Sensing of Accelerometer

### 6.3. The Received GSM Message Showing the Location of the Accident Spot (Figure 8)

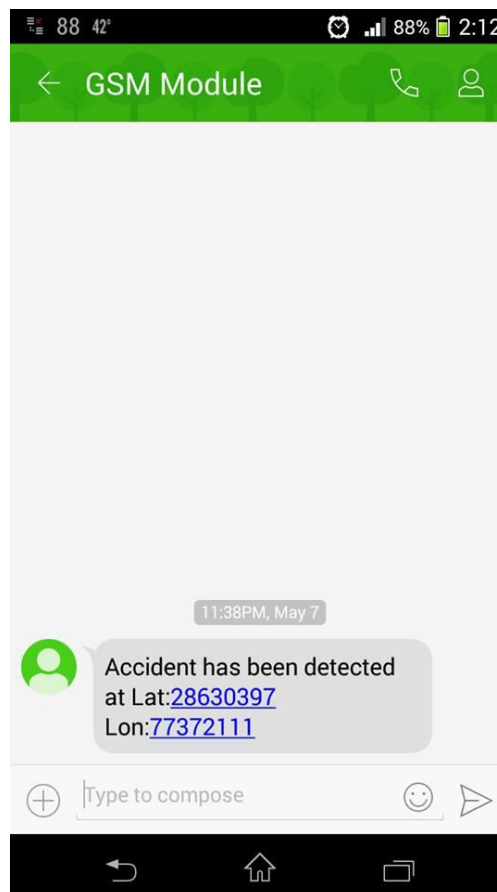
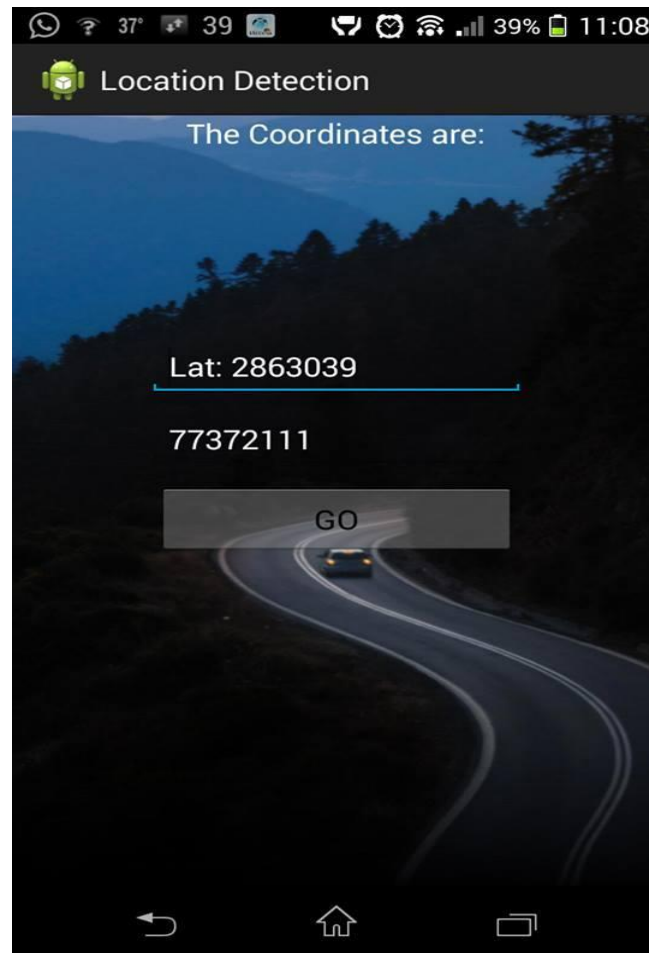

Figure 8. SMS Received

#### 6.4. The Android Application Showing the Output (Figure 9):



**Figure 9. Coordinates of Accident**

With the help of the crucial information regarding the accident and its spot, this accident detection and monitoring system provides emergency response in short span of time. And hence with the reduced time between the mishap and response a huge factor of mortality rate can be decrease. Although the conventional in-vehicles accident detection system are effective but these systems are expensive to install and cannot be interfaced in all vehicles. So it is needed to develop a system which can be installed on every possible vehicle with optimum cost.

#### 7. Future Scope

Sensors like alcohol detector, heart rate monitoring *etc.* can be interface in future modification of this project. To identify and tackle the risk of theft a biometric sensor may also come in handy that can be reprogramed to either switch off the ignition or to track the vehicle in such situations. Further using combination of all such data provided by sensors we can modify and enhance the functioning so that false triggering could be avoided. For example, air bag deployment can be modified to trigger over 60G's of acceleration. Even with the limitations smartphones can offer novel situational awareness. Smartphones application can provide significant aid in increasing the simplicity with low cost of maintenance. The updates of build-in application can make it more convenient for thousands of clients to upgrade the installation. It may also provide information about the identity of the victims and automatically alert their family and friends.

## References

- [1] Md. S. Amin, J. Jalil and M. B. I. Reaz, "Accident Detection and Reporting System using GPS, GPRS and GSM Technology", IEEE/OSA/IAPR International Conference on Informatics, Electronics & Vision.
- [2] S. K. Jose, X. Anitha Mary and N. Mathew, "ARM 7 Based Accident Alert and Vehicle Tracking System", International Journal of Innovative Technology and Exploring Engineering, vol. 2, Issue-4, (2013).
- [3] S. S. Chakole, V. R. Kapur and Y. A. Suryawanshi, "ARM Hardware Platform for Vehicular Monitoring and Tracking", International Conference on Communication Systems and Network Technologies, (2013).
- [4] W. Zhang and M. Jiang, "Design of Vehicle positioning System Based on ARM", IEEE Conference, (2011).
- [5] P. Chen and S. Liu, "Intelligent Vehicle Monitoring System Based on GPS, GSM and GIS", WASE International Conference on Information Engineering, (2010).
- [6] M. Fogue, P. Garrido, F. J. Martinez, J.-C. Cano, C. T. Calafate and P. Manzoni, "Prototyping an Automatic Notification Scheme for Traffic Accidents in Vehicular Networks", IEEE Conference, (2011).
- [7] H.-H. Lee and K.C. Lee, "Network-based fire-detection system for smart home automation", IEEE Transactions on Consumer Electronics, vol. 50, no. 4, (2004), pp. 1093-1099.
- [8] Y.-S. Jeong, B.-K. Kim, S.-S.Eom and S.-H.Hongand, "The study of applying sensor networks to a smart home", in Proceedings of Fourth International Conference onInformation Management, (2008), pp. 676-681.
- [9] V. Negi, H. Verma, I. Singh, A. Vikram, K. Malik, A. Singh and G. Verma, "Network Security in Embedded System Using TLS", International Journal of Security & its Applications, vol 10, no.2, (2016), pp. 375-384.
- [10] G. Verma, H. Verma, I. Singh, A. Vikram, S. Singhal, A. Kumar, S. Banarwal and K. Goel, "Wireless Position Tracking of a DTMF based Mobile Robot using GSM and GPS", Indian Journal of Science and Technology", vol 8, issue 17, IPL0161, (2015).
- [11] T. Gupta, H. Verma, G. Verma and L. Sahoo, "A Portable & Cost Effective Human Computer Interface Device for Disabled", in Proceedings of IEEE International Conference on Communication Systems and Network Technologies (CSNT-2015), pp. 1268-1273, (2015).
- [12] T. Gupta and G. Verma, "Area & Power Optimization of VPB Peripheral Memory for ARM7TDMI Based Microcontrollers", in Proceedings of IEEE International Conference on Cognitive Computing and Information Processing (CCIP-2015), (2015), pp. 1-6.