

Design of Sliding Mode Controller to Chemical Processes for Improved Performance

B. B. Musmade
Research Scholar
b_musmade@yahoo.com

R. K. Munje
Research Scholar
ravimunje@yahoo.com

B. M. Patre
Professor of
Instrumentation
bmpatre@yahoo.com

*S. G. G. S. Institute of Engineering and Technology,
Nanded-431606, India.*

Abstract

This paper presents design of continuous-time sliding mode controller for chemical processes which are adequately approximated by first order plus dead time (FOPDT) model. It is observed that the sliding mode controller is effective over classical PID controller to regulate nonlinear chemical processes through linearized model in terms of performance and robustness. Most widely used processes like continuous yeast fermentation, two capacity process and isothermal chemical reactor are considered to show the efficacy of the sliding mode controller over PID controller.

Keywords: *sliding mode control, FOPDT model, continuous yeast fermenter, nonminimum phase process, isothermal chemical reactor.*

1. Introduction

During the past few decades, the robust control system design for unstable processes has received considerable attention from control community. Among the established design approaches for robust process control, sliding mode control (SMC) plays an important role because it not only can stabilize the system but also provide the capability of disturbance rejection and insensitivity to parameter variations [1,2]. Basically, the SMC design is composed of two stages. A sliding surface on which the process dynamics is restricted. Subsequently, a feedback control law such that any system trajectory outside the sliding surface is driven to reach the surface in a finite time and keep on it. This therefore makes the closed-loop SMC system robust to matched uncertainties and external disturbances. Due to the significant fact that the sliding mode control theory has the ability to deal with process uncertainties, much effort has been concentrated on the design of various sliding mode control systems in order for handling with diversified process dynamics. To control nonlinear processes, the combination of use of differential geometric approach and sliding mode strategy has been proven to be a promising way to the robust control and many advanced SMC schemes have been developed [3,14]. Process model relating the controlled and manipulated variables are of higher order. The Sliding Mode Controller could be designed to control the nonlinear system with the assumption that the robustness of the controller will compensate for modeling errors arising from the linearization of nonlinear model through model reduction method. An efficient alternative modeling method for process control is to use of empirical models, which use low order linear models with dead time. Most times, first order plus dead time (FOPDT) models are adequate for process control analysis and design. But these reduced order models

present uncertainties arising from imperfect knowledge of the models, and the nonlinear effect contribute to performance degradation of the controller [17]. The aim of the paper is to design sliding mode controller based on FOPDT model for typical chemical processes. Paper is organized as follows. Section 2 briefly presents notion of sliding modes in variable structure systems, Design of continuous sliding mode control and development of sliding mode controller described in section 3 and 4. In section 5 typical chemical processes used in process plants are considered for simulation studies. Results of sliding mode controller in comparison PID controller are given and section 6 concludes the paper with acknowledgements in section 7.

2. Sliding Modes in Variable Structure Control

The underlying idea of sliding mode control is variable structure control. In variable structure control, the structure of the control input is changed in accordance to the system states. This, in turn would result in dynamics that was not realizable with any of the constituent control structures working alone. This property of variable structure control may be illustrated by the following example. For the purpose of illustration consider the second order system [1,2,15],

$$\ddot{x} = -ux \tag{1}$$

having the structures defined by $u = \alpha_1^2$ and $u = \alpha_2^2$ with $\alpha_1^2 > \alpha_2^2$. The resultant dynamics in both cases would be concentric ellipses in the phase plane. Hence, the system is not asymptotically stable. However, the system can be made to be asymptotically stable by changing the dynamics at the co-ordinate axes with the switching logic

$$u = \begin{cases} \alpha_1^2 & \ddot{x}\dot{x} < 0 \\ \alpha_2^2 & \ddot{x}\dot{x} > 0 \end{cases} \tag{2}$$

It can be seen in this example that even though none of the systems were asymptotically stable as shown in Figure 1(a), 1(b); the application of variable structure systems (VSS) has rendered the composite system to be asymptotically stable as illustrated in Figure 1(c) and Figure 1(d). Figure 1(c) shows variable structure control law and Figure 1(d) shows resultant sliding motion of trajectory.

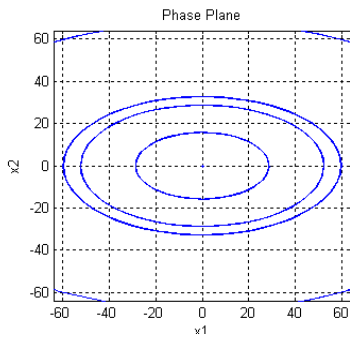

Figure 1(a): Phase plane of $u = \alpha_1^2$

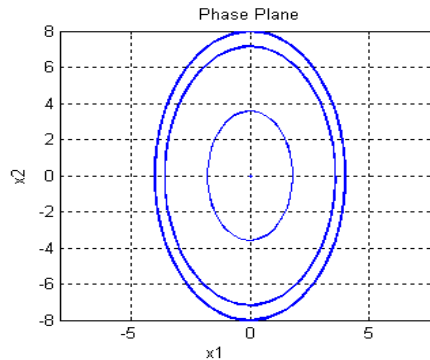

Figure 1(b): Phase plane of $u = \alpha_2^2$

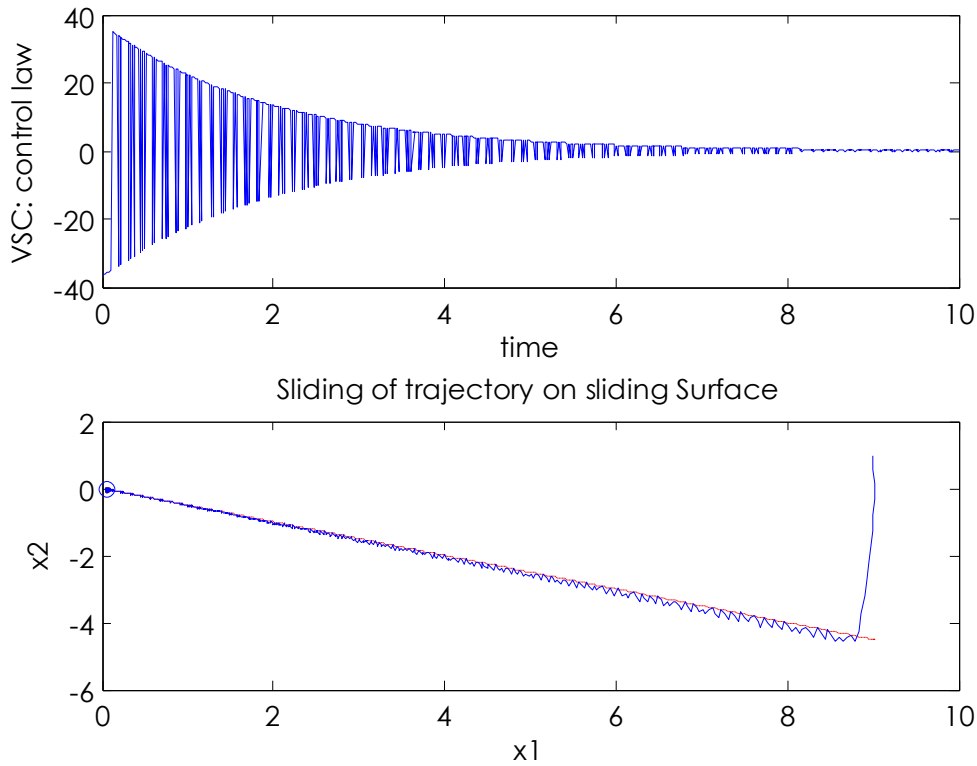

Figure 1(c) & 1(d): Asymptotic stability of VSS with Lyapunov Stability Systems

3. Continuous-time Sliding Mode Control

The two fold control law is of reaching mode and the sliding mode control law. The first of these is designed in order to reach the desired surface where as the controlled system dynamics on the sliding surface. In designing the sliding mode controller, is to choose the sliding surface, $s(t)$ to represent a desired global behavior for tracking performance. The $s(t)$ selected in this work is an integro-differential equation acting on tracking error expression [14].

$$s(t) = \left(\frac{d}{dt} + \lambda\right)^n \int_0^t e(t) dt \quad (3)$$

where $e(t)$ is tracking error, λ is tuning parameter and n is the order of the system. The objective is to force the state (error) to move on switching surface $s(t)=0$ Once the reference value is reached, $s(t)$ reaches a constant value. To maintain $s(t)$ at this constant value meaning that $e(t)$ is zero at all times; it is desired to make

$$\frac{ds(t)}{dt} = 0 \quad (4)$$

The second step is to design the control law which drives the controlled variable to its reference value and satisfies equation (4). The complete SMC control law, $u(t)$ is given by equation (5)

$$u(t) = u_C(t) + u_D(t) \quad (5)$$

where $u_D(t)$ incorporates a non-linear element that includes the switching element of control law given by equation ,

$$u_D(t) = K_D \frac{s(t)}{|s(t)| + \delta} \quad (6)$$

With K_D as tuning parameter responsible for reaching mode, δ as tuning parameter used to reduce chattering.

4. Development of Sliding Mode Controller

This section shows the design of sliding mode controller based on linearization of nonlinear system. The identified FOPDT model of the form,

$$G(s) = \frac{Ke^{-t_0s}}{\tau.s + 1} \quad (7)$$

Linearization of this model is done using first order approximations like Pade's or Taylor's series approximation for deadtime term is considered as follows,

$$e^{-t_0s} \cong \frac{1}{t_0s + 1} \quad (8)$$

In time domain from (7) and (8) we get,

$$u(t) = \frac{t_0\tau}{K} \frac{d^2x(t)}{dt^2} + \frac{(t_0 + \tau)}{K} \frac{dx(t)}{dt} + \frac{x(t)}{K} \quad (9)$$

From this we can say that the order of the system is two i.e. sliding surface defined in the equation (9) will be given by the equation

$$s(t) = \frac{d}{dt} e(t) + 2\lambda e(t) + \lambda^2 \int_0^t e(t) dt \quad (10)$$

Differentiating above equation of sliding surface to get,

$$\frac{d}{dt} s(t) = \frac{d^2}{dt^2} e(t) + 2\lambda \frac{d}{dt} e(t) + \lambda^2 e(t) = 0 \quad (11)$$

Again $e(t) = r(t) - x(t)$ and $r(t)$ is the reference value which is constant. Hence derivative of the constant value is zero and the equation (10) reduces to

$$\frac{d^2x(t)}{dt^2} = -2\lambda \frac{dx(t)}{dt} + \lambda^2 e(t) \quad (12)$$

From (9) and (12) we get,

$$u_C(t) = \frac{t_0\tau}{K} \left\{ \left[\frac{t_0 + \tau}{t_0\tau} - 2\lambda \right] \frac{dx(t)}{dt} + \lambda^2 e(t) + \frac{x(t)}{t_0\tau} \right\} \quad (13)$$

We can simplify the controller by making derivative of controlled variable as zero by making assumption

$$\frac{t_0 + \tau}{t_0\tau} = 2\lambda \quad (14)$$

Hence from equation (5) complete control law will be

$$u(t) = \frac{t_0 \tau}{K} \left\{ \lambda^2 e(t) + \frac{x(t)}{t_0 \tau} \right\} + K_D \frac{s(t)}{|s(t)| + \delta} \quad (15)$$

And the sliding function is

$$s(t) = \text{sign}(K) \left[\frac{-dx(t)}{dt} + 2\lambda e(t) + \lambda^2 \int_0^t e(t) dt \right] \quad (16)$$

Equations (15) & (16) constitute controller expression. Fixed structure depending on the λ and characteristic parameters of the FOPDT model and second the action of the controller is considered in the sliding surface equation, by including the term $\text{sign}(K)$. The tuning parameters K_D and δ are determined from Nelder-Mead search algorithm is as follows [3,4,5,6].

$$K_D = \frac{0.51}{|K|} \left(\frac{\tau}{t_0} \right)^{0.76} \quad (17)$$

$$\delta = 0.68 + 0.12 |K| K_D * 2 * \lambda \quad (18)$$

5. Simulation Studies

To verify the effectiveness and applicability of sliding mode controller, it is applied to typical minimum and nonminimum phase processes and the results are compared with well tuned PID controller.

5.1. Continuous Yeast Fermentation Process

With the presence of living organisms, the control of fermentation process is more complex than conventional chemical reactor. The dynamics of the fermentation process are highly nonlinear and poorly understood. Besides being influenced by external conditions yeasts have their own regulatory mechanism, which mean that the model parameters may not remain unchanged over long time. Therefore we can only change the extracellular environment, which we hope it would affect mechanism rightly. Figure 2 depicts the continuous yeast fermentation process. The fermenter receives a stream, with unknown temperature, T_i unknown glucose (feed substrate) concentration, S_f . Temperature of the fermenter, T is controlled by manipulating the jacket flow rate, F_j . Few assumptions like Fermenter & Jacket are perfectly mixed, Inlet stream is equal to outlet stream i.e. volume is constant, physical parameters, such as density and heat transfer coefficients are constant. Table 2, shows the steady state conditions and other operating information of the continuous yeast fermentation process [9,12,13,18,19,20].

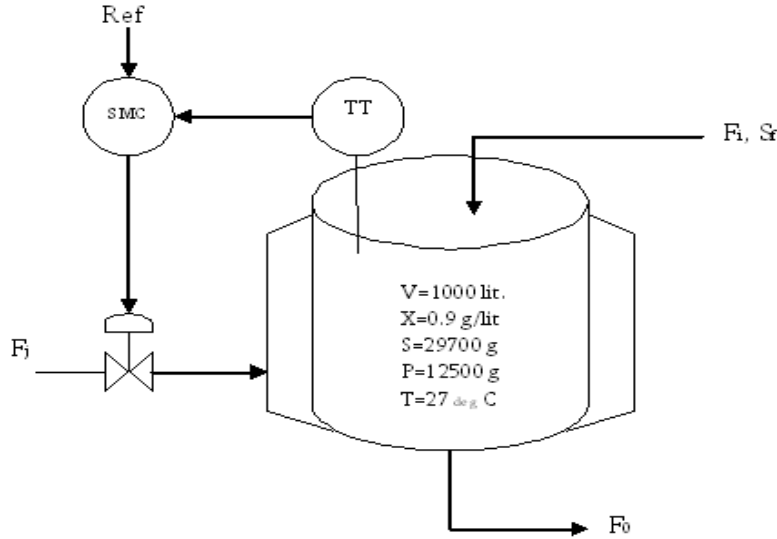

Figure 2: Continuous yeast fermentation process

Table 1: Steady State Values-Parameters of the process model

Fermenter Volume, V	1000 lit
Yeast Concentration, X	0.9 g/lit
Glucose Concentration, S	29.7 g/lit
Ethanol Concentration, P	12.5 g/lit
Jacket Temperature, T_j	29.33 °C
Fermenter Temperature, T	27 °C
Inlet Flowrate, F_i = Outlet Flowrate, F_o	51 lit/hrs
Feed Substrate Concentration, S_f	60 g/lit
Inlet Temperature, T_i	25 °C
Flow rate of Jacket, F_j	20 lit/hrs
Jacket Volume, V_m	25 lit
Area of Heat Transfer, A_T	1 m ²
Heat Transfer Coefficient, K_T	3.6e5 J/ hrm ² K
Density of the mixture, ρ	1080 g/lit
Density of cooling water, ρ_j	1000 g/lit
Specific heat Capacity of mixture, C_p	4.18 J/gK
Sp. Heat Capacity of cooling water, C_p	4.18 J/gK

Activation energy for growth, E_a	55000 j/mol
Activation energy for thermal death, E_d	220000 j/mol
Constant of growth inhibition by ethanol, K_p	0.139 g/l
Const. of fermentation inhibition by ethanol, K_{pI}	0.070 g/l
Constant in substrate term for growth, K_s	1.030 g/l
Constant in substrate term for ethanol production, K_{sI}	1.680 g/l
Universal gas constant, R	8.31 J/mol. K
Growth yield coefficient for ethanol, R_{sp}	0.435
Growth yield coefficient for cells, R_{sx}	0.607
A_1 , pre-exponential factor in Arhenius equation	9.5×10^8
A_2 pre-exponential factor in Arhenius equation	2.55×10^{33}

The process model is described by the following nonlinear differential equations. The reactor is modeled as a continuous stirred tank with constant feed flow. Mass balance of yeast concentration is estimated as follows

$$\frac{dX}{dt} = \mu_x X - DX \quad (19)$$

where D is dilution rate in hrs^{-1} and μ_x is specific growth rate in hrs^{-1} .

$$\mu_x = \frac{\mu_m S}{K_s + S} e^{-P/K_p} (A_1 e^{-E_a/RT} - A_2 e^{-E_d/RT}) \quad (20)$$

where μ_m -Max. Specific fermentation rate h^{-1} . The growth rate model is a function of glucose concentration, alcohol concentration and temperature which is in $^{\circ}K$. Alcohol is inhibitory for the yeast for the concentration above 5%. In such case specific growth rate is multiplication of function of each factor. Mass balance for the glucose concentration is,

$$\frac{dS}{dt} = -\frac{\mu_x X}{R_{sx}} - \frac{\mu_p X}{R_{sp}} + D(S_f - S) \quad (21)$$

where μ_p maximum specific fermentation rate (h^{-1}), μ_x maximum specific growth rate (h^{-1}), R_{sx} and R_{sp} are the growth yield coefficients for yeast and alcohol respectively. Mass balance for the product, ethanol concentration is,

$$(22)$$

Rate of production of ethanol is estimated as follows

$$\frac{dP}{dt} = \mu_p X - DP \quad (23)$$

Thermal balance for the fermenter

$$\frac{dT}{dt} = \frac{\mu_x X}{\rho C_p Y_H} - \frac{K_T A_T}{\rho C_p V} (T - T_j) + D(T_i - T) \quad (24)$$

where Y_H is the is heat evolved per gram, g yeast/J and thermal balance for the jacket

$$\frac{dT_j}{dt} = \frac{F_j}{V_m} (T_{ji} - T_j) + \frac{K_T A_T}{V_m \rho_j C_{Pj}} (T - T_j) \quad (25)$$

Thus model consists of five differential equations. Above material and energy balance equations that describe the behavior of continuous yeast fermentation process are non-linear. Using the linearized model and the steady state operating values, transfer function is determined. Time is estimated in *hrs*. The FOPDT model is given by

$$G(s) = \frac{-0.146169}{16.2737s + 1} e^{-1.8706s} \quad (26)$$

Step response of the FOPDT model and the actual process is compared in the Figure 3.

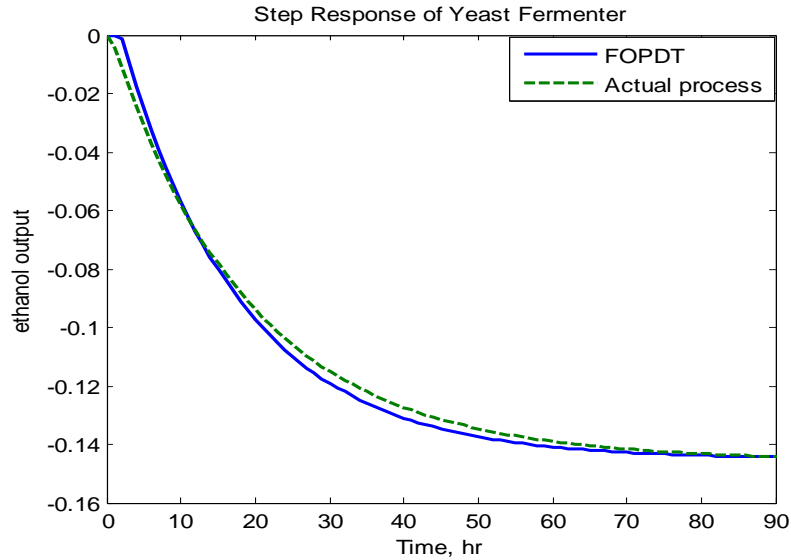

Figure 3: Comparison of step responses of actual process & FOPDT Model.

The model is simulated with effect of variations in flow of jacket, F_j and inlet temperature, T_i and output variables are examined. For continuous yeast fermentation process the sliding mode controller is designed and PID controller using Zeigler & Nichols Method [7] are tabulated as follows

Table 2: Tuning parameters of Sliding mode controller and PID controller

PID Parameters	Values	SMC Parameters	Values
K_c	-53.56	K_D	18.0609
T_i	6.1730	δ	0.8688
T_d	0	λ	0.2981

The simulation results of the sliding mode controller in comparison with PID are shown in Figure 4 and 5.

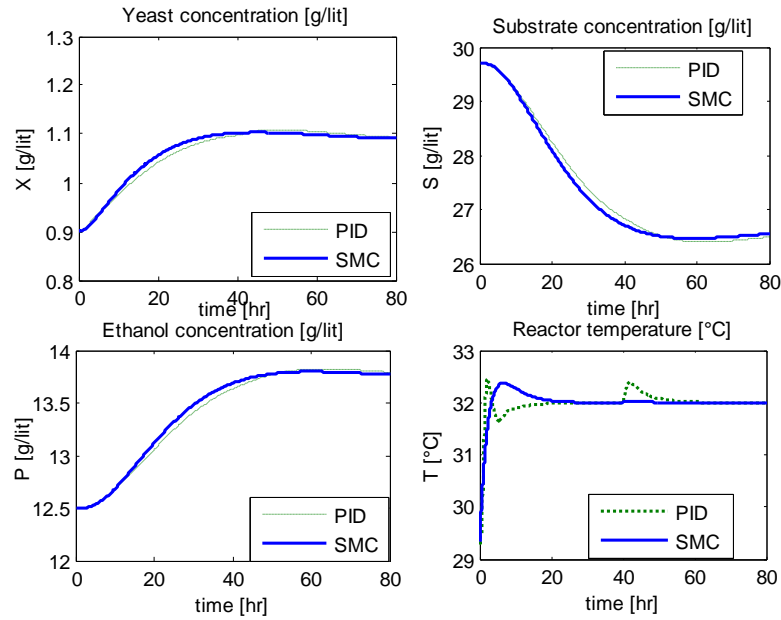

Figure 4(a) +25% increase in the inlet temperature at 32 °C

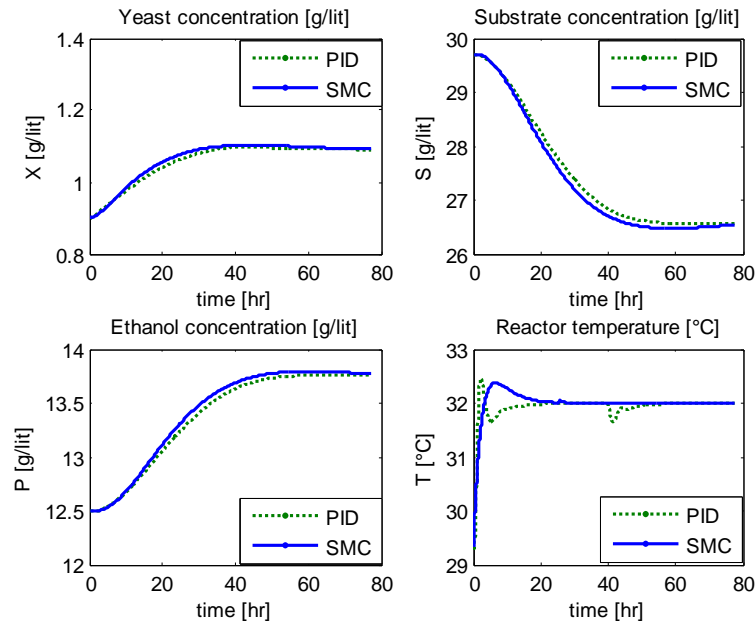

Figure 4(b) – 25% decrease in the inlet temperature at 32 °C

Figure 4: The response of fermenter when subjected to the change in disturbance input (inlet temperature).

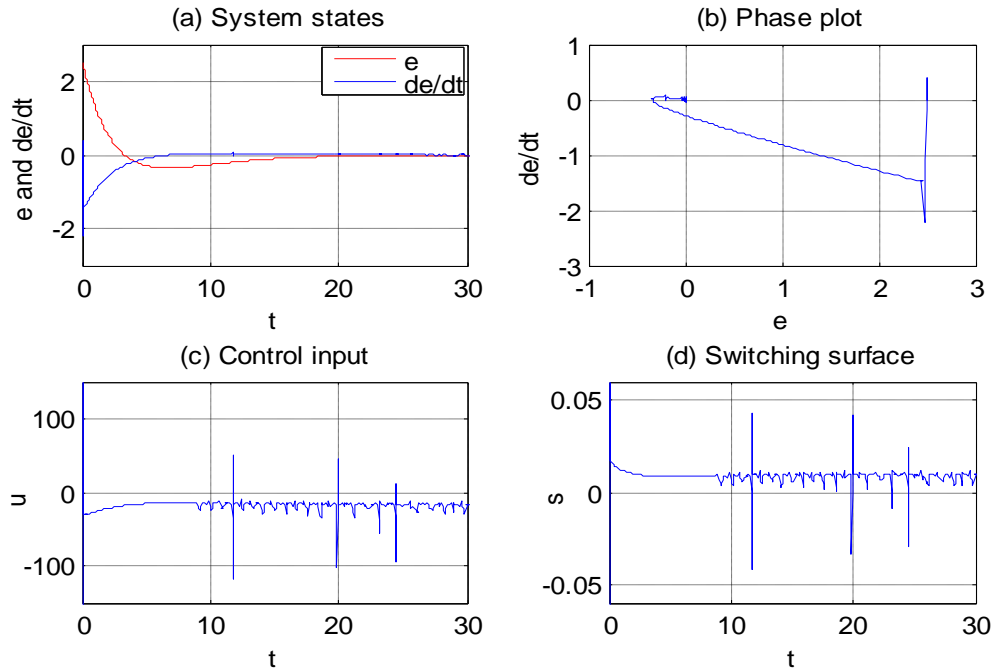

Figure 5: Response of the system with control law; (a) System states (e-state1 & de/dt-state2), (b) Phase plot, (c) Control input, (d) Switching surface

5.2. Two Capacity Process

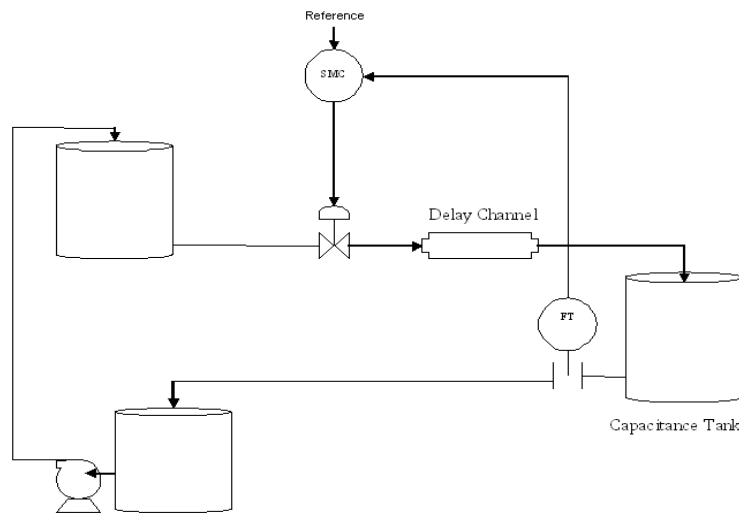

Figure 6: Two Capacity Process

The process consists of reservoir tank that feeds water using control valve and delay channel to capacitance tank from the bottom of which the water flows through an orifice type flow meter to sump tank, which it is returned via a pump to the reservoir. The schematic is as shown in figure 6. The control strategy is to monitor outflow rate (controlled variable) of the

capacitance tank by controlling valve process (manipulating variable). The transfer function of process plant is as follows. Two time constants i.e. 1.1 minutes and 0.21 minutes are associated with the capacitance tank and delay channel respectively, while the transport lag, 0.25 minutes is associated with the delay channel [8,9,10,21].

$$G(s) = \frac{1.68e^{-0.25s}}{(1.1s + 1)(0.21s + 1)} \quad (27)$$

The reduced model of two capacity process is as follows

$$G_{pr} = \frac{1.68e^{-0.26s}}{1.2158s + 1} \quad (28)$$

Figure 7, shows the comparison of step response. The sliding mode controller and PID tuning parameters of as follows

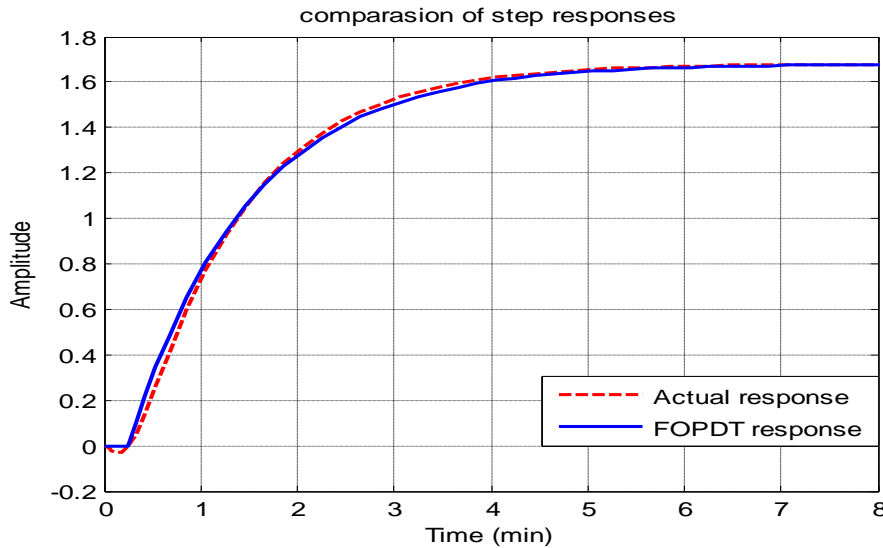

Figure 7: shows the comparison of step response

The controllers parameters are tabulated as follows.

Table 4: Tuning parameters of SMC and PID

PID Parameters	Values	SMC Parameters	Values
K_c	3.3401	K_D	0.9803
T_i	0.52	δ	1.6027
T_d	0.13	λ	2.334

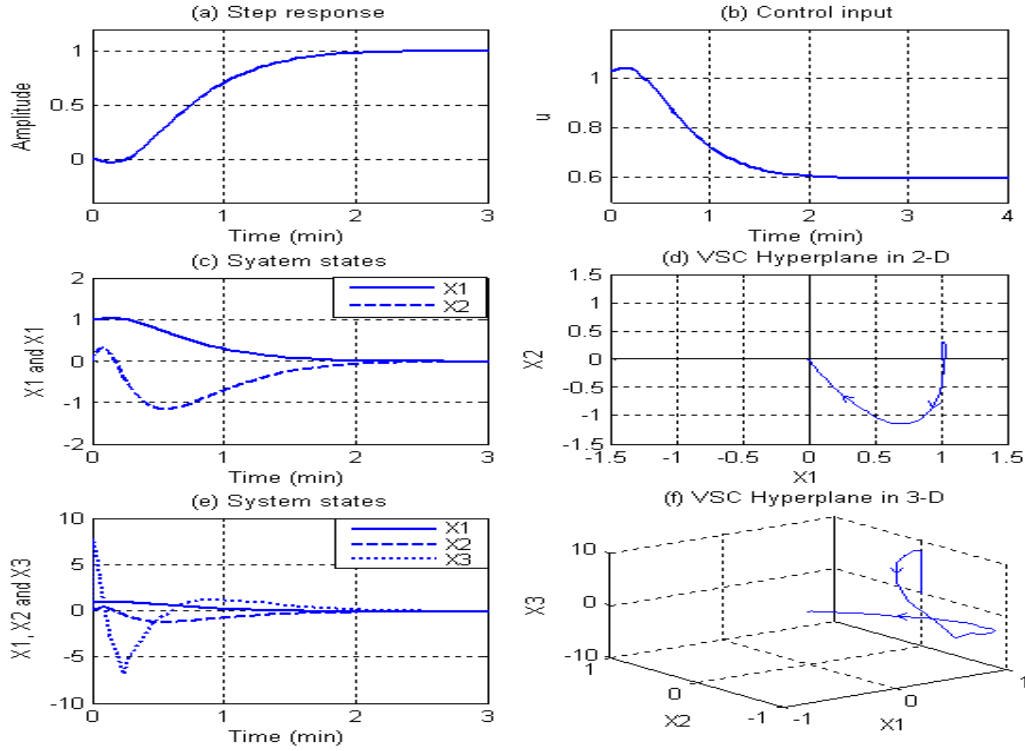

Figure 8: Control performance of SMC.

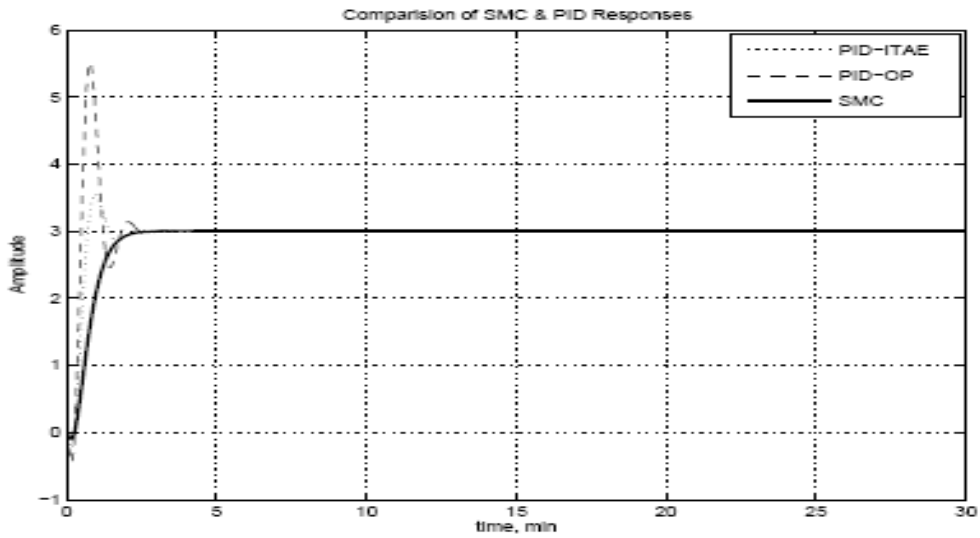

Figure 9: Comparative of control performances SMC and PID.

5.3 Isothermal Chemical Reactor

Another typical process is an isothermal chemical reactor; the product concentration is controlled by manipulating the feed flow rate, which changes the residence time for constant volume reactor. The schematic diagram of the reactor is shown in the Figure 15.

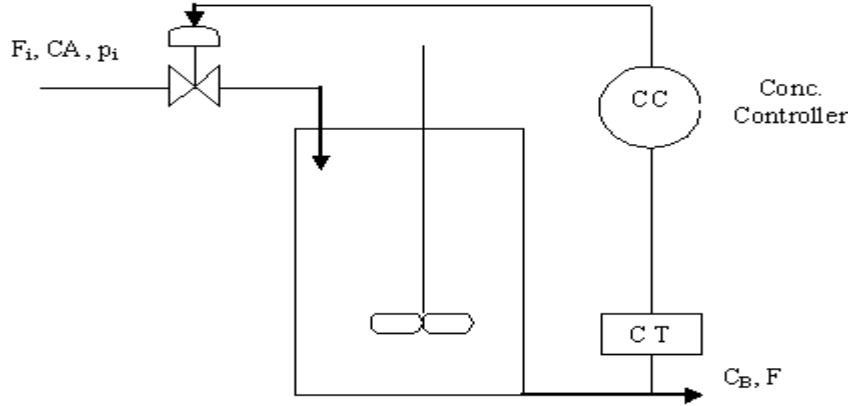
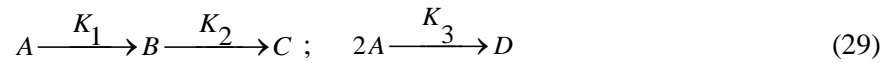

Figure 10 – Schematic- Isothermal Chemical Reactor

The Van de-vusse reaction given by (29) is under consideration and the desired product is the component B.



For reactor model overall mass balance equation is given by

$$\frac{d(\rho V)}{dt} = \rho_i F_i - \rho F \quad (30)$$

where V is the volume in liter, F_i is feed flow rate and F is output flow rate in *liter/min*, and ρ_i and ρ are the feed flow density and output flow density respectively. Assuming constant density i.e. $\rho_i = \rho$ then, equation (30) reduces to

$$\frac{dV}{dt} = F_i - F \quad (31)$$

The component material balance of A is given by

$$\frac{d(C_A V)}{dt} = C_{A_i} F_i - C_A F + r_A V \quad (32)$$

where C_A is concentration of component A in g mol/liter, C_{A_i} is the concentration of component A in feed flow in g mol/liter and r_A represents generation of species of A per unit volume. It is given by the equation

$$r_A = -K_1 C_A - K_3 C_A^2 \quad (33)$$

where K_1 and K_3 are the reaction rate constants of equation (29), From the equation (32),

$$\frac{d(C_A V)}{dt} = V \frac{dC_A}{dt} + C_A \frac{dV}{dt} \quad (34)$$

Hence equation (32) can be written as

$$\frac{dC_A}{dt} = \frac{F_i}{V} (C_{Ai} - C_A) - K_1 C_A - K_3 C_A^2 \quad (33)$$

Then, Component material balance for B is given by

$$\frac{d(C_B V)}{dt} = -C_B F + r_B V \quad (34)$$

where C_B is the concentration of component B in g mol/liter and r_B is generation of species of B per unit volume, which is given by

$$r_B = K_1 C_A - K_2 C_B \quad (35)$$

where K_2 is reaction rate constant for the equation (29), (30) equation (34) can be written as

$$\frac{dC_B}{dt} = -\frac{F_i}{V} C_B + K_1 C_A - K_2 C_B \quad (36)$$

Thus model consists of three differential equations therefore three state variables. Often other simplifying techniques are made to reduce the number of differential equations to make them easier to analyze and faster to solve. Assuming constant volume, resulting differential equations governing the isothermal chemical reactor are given by following equations

$$\frac{dC_A}{dt} = \frac{F_i}{V} (C_{Ai} - C_A) - K_1 C_A - K_3 C_A^2 \quad (37)$$

$$\frac{dC_B}{dt} = -\frac{F_i}{V} C_B + K_1 C_A - K_2 C_B \quad (38)$$

Here we consider $F/V=D$ as the manipulated variable/input, C_A and C_B as state variables, C_{Ai} as disturbance input and C_B as output variable [9].

For one particular situation, $C_{As}=3$ g mol/liter, $F_s/V=D_s=0.5714$ min⁻¹ $C_{Bs}=1.117$ g mol/liter, $K_1=5/6$ min⁻¹, $K_2=5/3$ min⁻¹ and $K_3=1/6$ min⁻¹. The manipulated input output transfer function for the reactor is,

$$G(s) = \frac{X(s)}{U(s)} = \frac{-1.1170s + 3.1472}{s^2 + 4.6429s + 5.3821} \quad (39)$$

where X(s) and U(s) are laplace transform of controlled and manipulated variables respectively. Here $F/V = D$ manipulated variable. C_A , C_B are state variables and C_{Ai} as disturbance input and C_B as controlled variable.

The reduced order model FOPDT model of reactor is as follows

$$G_{pr} = \frac{0.585e^{-0.48s}}{0.74s + 1} \quad (40)$$

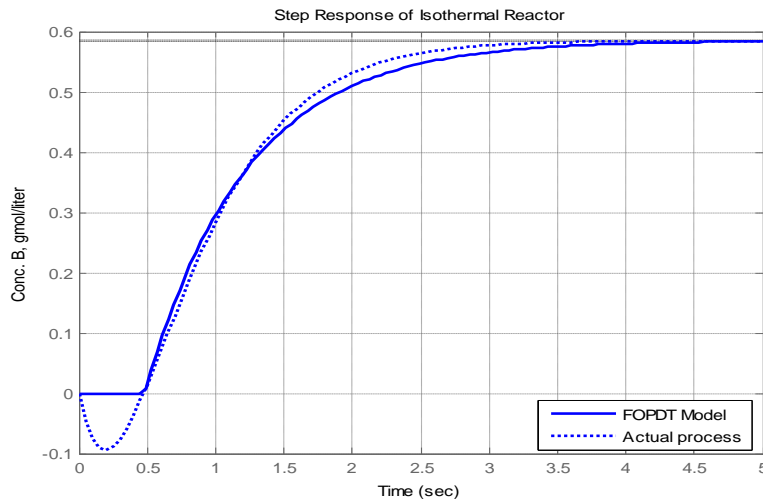

Figure 11: Step responses of actual reactor and its FOPDT model.

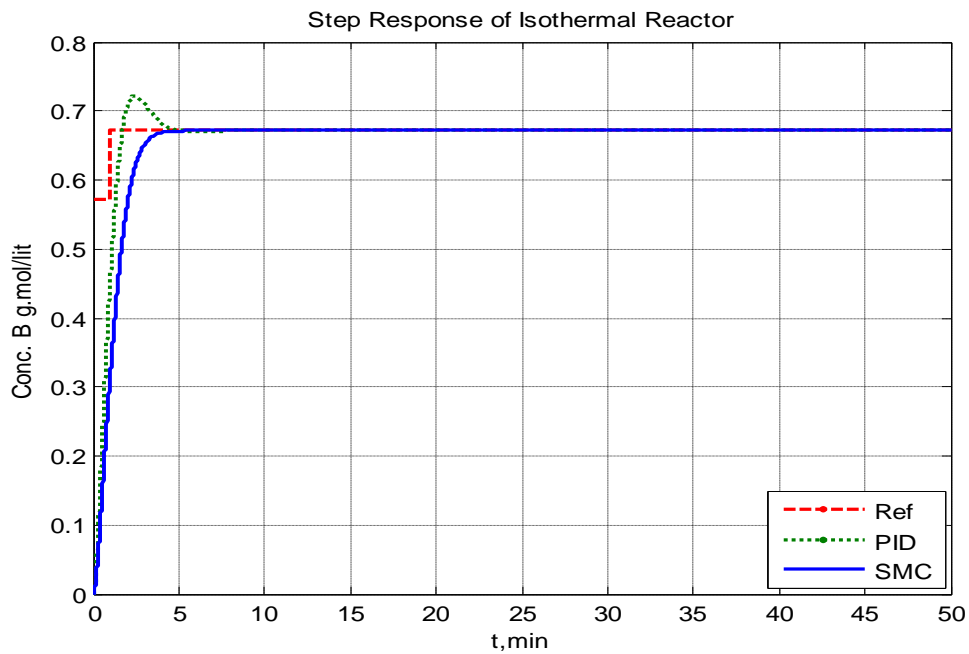

Figure 12: The Comparative control performance of SMC and PID controller

6. Conclusion

A simple sliding mode controller strategy is designed based on linearization of nonlinear process model. Then this method is applied for continuous yeast fermentation process. To broaden the scope of this method applications are extended to nonminimum phase behavior processes. In conclusion the proposed sliding mode controller can yield a better dynamic performance than conventional controllers. Hence it can be proved that performance of

sliding mode controller is more robust against setpoint changes and disturbances compared to conventional strategies.

Acknowledgement

The authors would like to thank the University of Pune, India for financial support under the grant UNIPUNE/BCUD/31/0910-0153.

References

- [1] J. Y. Hung, W. Gao and J. C. Hung. "Variable Structure Control: A Survey", IEEE Trans. on Industrial Electronics, Vol. 40, No. 1, February 1993, pp. 2-22.
- [2] K. D. Young, V. I. Utkin and U. Ozguner., "A Control Engineers Guide to Sliding Mode Control", IEEE Trans. on Control System Technology, Vol. 7, No. 1, May 1993, pp. 328-342.
- [3] O. Camacho and C. A. Smith, "Sliding Mode Control: an Approach to Regulate Nonlinear Chemical Processes", ISA Transaction, Vol. 39, 2000, pp. 205-218.
- [4] O. Camacho, R. Rojas and W. Garcia. "Some Long Time Delay Sliding Mode Approaches", ISA Transaction, Vol. 46, 2007, pp. 95-101.
- [5] O. Camacho, R. Rojas and W. Garcia., "Variable structure control applied to chemical processes with inverse response", ISA Transactions, Vol. 38, 1999, pp. 55-72.
- [6] O. Camacho and C. A. Smith, 'Application of sliding mode control to nonlinear chemical processes with variable deadline. Proceedings of 2nd Congress of Colombian Association of Automatics, Colombia, 1997, 122-128.
- [7] J. G. Ziegler and N. B. Nichols., 'Optimum settings for Automatic Controllers', Transactions of ASME, Vol. 64, 1942, pp. 759-768.
- [8] N. B. Almutairi and M. Zribi., "Sliding Mode Control of Coupled Tanks", Mechatronics, Vol. 16, 2006, pp. 427-441.
- [9] B. W. Bequette, "Process Control: Modeling, Design and Simulation", Prentice Hall of India, August 2003.
- [10] W. L. McCabe and J. C. Smith, "Unit Operations of Chemical Engineering", McGraw Hill, New York, 1991.
- [11] R. Rojas, O. Camacho and L. Gonzalez, "A Sliding Mode Control proposal for open loop unstable processes", ISA Transactions, Vol. 43, 2004, pp. 243-255.
- [12] Z. K. Nagy. "Model Based Control of a Fermentation Bioreactor using Optimally Designed Artificial Neural Networks", Chemical Engineering Journal, Vol. 127, 2007, pp. 95-109.
- [13] Prescott and Dunn, 'Industrial Microbiology', CBS Publishers, 4th Edition, 1991, pp. 292-378.
- [14] J. J. Slotine and W. Li., "Applied nonlinear control", Prentice Hall, New jersey, 1991.
- [15] B. M. Patre and B. Bandopadhyay, "Robust Variable Structure Model Following Controller for Load Frequency Control", System Science, Vol. 28, 2002, 43-60.
- [16] O. Camacho and F. D. Cruz. Smith Predictor Based-Sliding Mode Controller for Integrating Processes with Elevated Deadline. ISA Transactions, Vol. 43, 2004, pp. 257-270.
- [17] R. A. Decarlo and H. Z. Stanislaw., "Variable structure control of Nonlinear Multivariable Systems: A Tutorial", Proceedings of the IEEE, Vol. 76(3), 1988, pp. 212-232.
- [18] C. Machado et al., "Control of bakers yeast fermentation: PID and fuzzy algorithms. In Proceedings of the 27th Annual Conference of the IEEE Industrial Electronics Society, Colorado, USA, 2001, p. 770-775.
- [19] K. Muthuswamy and R. Srinivasan., "Phase-based supervisory control for fermentation process development", Journal of Process Control, Volume 13, Issue 5, August 2003, Pages 367-382.
- [20] H. Zhan, "Optimal control of a fed-batch yeast fermentation process based on Least Square Support Vector Machine", In International Journal of Engineering Systems Modelling and Simulation, Volume 1, Issue 1, 2008, Pages 63-68.
- [21] P. P. Biswas, R. Srivatava S. Ray and A. N. Samanta., "Sliding Mode control of quadruple tank process", Mechatronics, Vol. 19, 2009, pp. 548-561.

Authors



B. B. Musmade received B. E. & M. E. degrees in Instrumentation & Control Engineering from the Pune University, India, in 1996 and 2006 respectively. Currently, he is a Asst. Professor in the Department of Instrumentation Engineering at M.V.P. Samaj's K.B.T. College of Engineering, Nashik, India. Also, he is Research Scholar at S.G.G.S Institute of Engineering and Technology, Vishnupuri, Nanded - 431606, India. He has published about 15 refereed journal and conference papers. His research interest covers Sliding mode control, process instrumentation and modern control theory. He is a member of ISTE and ISOI. E-mail: b_musmade@yahoo.com.



R. K. Munje received B.E. and M.E. degrees in Electrical Engineering from the Mumbai and Pune University, India, in 2005 and 2009 respectively. Currently, he is a Senior lecturer in the Department of Electrical Engineering at Sandip Institute of Engineering and Management, Nashik, India. Also, he is Research Scholar at S.G.G.S Institute of Engineering and Technology, Vishnupuri, Nanded - 431606, India. He has published about 6 refereed journal and conference papers. His research interest covers Control Systems, Sliding mode control, Nuclear Reactor Engineering. He is a member of ISTE E-mail: ravimuje@yahoo.co.in.



B. M. Patre received his B. E. and M. E. degrees in Instrumentation Engineering from the S.G.G.S Institute of Engineering and Technology, Nanded, India, in 1986 and 1990, respectively, and the Ph. D. degree in Systems & Control engineering from IIT Bombay, India in 1998. Currently, he is a Professor in Instrumentation Engineering at S.G.G.S Institute of Engineering and Technology, Nanded, India. He has published about 100 refereed journal and conference papers. His research interest covers Robust control, feedback control systems and intelligent control. Prof. B. M. Patre received research grants form AICTE, DST, BARC and BRNS. He is a member of IEEE, ISTE, IETE, ISOI, IE(India). E-mail: bmpatre@yahoo.com(Corresponding Author). Fax: +91-2462-229236.

