

Passivity Based Control of Doubly Fed Induction Machine Using a Fuzzy Controller

¹Salim Aissi, ¹Lamir Saidi, ¹Rachid Abdessemed, and ²Fakhr-Eddine Ababsa

¹*Department of Electronics, Batna University, Algeria*

²*Laboratoire des Systèmes Complexes, Université d'Evry Val d'Essonne, France*

*salim.aissi@gmail.com, lamir_saidi@yahoo.fr
r.abdessemed@lycos.com, Fakhr-Eddine.ababsa@iup.univ-evry.fr*

Abstract

In this paper, we are interested in the control of a Doubly Fed Induction Machine (DFIM) operating in motor mode. The proposed structure is based on the association of passivity and fuzzy control. The main objective of this configuration is to optimally regulate the motor speed according to variable references as well as tracking of the time-varying speed, the electromagnetic torque and the flux trajectories without a state observer. Simulation results showed remarkable efficiency in terms of stability and robustness of this structure with respect to parameter variations and disturbances. Results are compared with an existing work to show up the main points of our contribution.

Keywords: *Passivity based control, Lagrangian Model, DFIM, Fuzzy Controller*

1. Introduction

The use of DFIM in variable speed applications in comparison to other types of machines is justified by highly performance of power transfer in both motor and generator modes. Many DFIM controllers are presented in literature using vector control techniques with good response performances, decoupling flux regulation, and reasonable electromagnetic torque [1-2]. However, in this approach, the value of the flux is not accessible; consequently, either a direct or an estimation of the flux is necessary. To overcome the use of an observer, passivity method is then applied to control the DFIM. The main advantage of the proposed approach results in a reduced computational time, and an extremely alleviated structure in terms of the number of dynamic elements.

Passivity Based Control (PBC) is a technique that depends on the structure passivity, which transforms the system into another passive system having a different energy function leading to the equilibrium point [3-6]. The PBC is a technique based on the Euler-Lagrange modeling which is carried out due to the fact that it allows a description of large classes of physical systems using total energy principle. The aim of this strategy is to bring the system dynamics to the desired values; furthermore it ensures a speedy convergence of the desired behavior via feeding back the outputs.

Various references, mainly [7-8], evolve the PBC controller without any observer for the induction machine. The same approach is applied to the DFIM by formulating the energy procedure to the electrical part by considering the mechanical effects as passive disturbances [3-4, 9]. In this case, the control problems are solved by using only the accessible variables, and tracking of both the electromagnetic torque and rotor flux amplitudes is obtained using an

internal closed loop. In order to enhance this tracking, this paper proposes an association of fuzzy control and PBC that allows trajectory planning of mechanical speed, electromagnetic torque, and flux.

This paper is organized as follows: The proposed method of Passivity-Fuzzy Logic Controller (PFLC) is presented in section 2. The next section describes the system to be controlled (Lagrangian form using the well-known Blondel–Park synchronous α, β coordinates), as well as the establishment of the desired functioning, and the error dynamics of the equilibrium points. Simulation results are shown in section 4. Finally, the contribution of this work is summarized in section 5.

2. Proposed PFLC

In this work, we propose a structure based on the nested loop control where the outer loop provides the speed control via the fuzzy controller strategy. The inner loop used in the classical PBC [6-8, 10] is transformed into two dynamic feedbacks exploiting the measured states (stator and rotor currents).

The proposed controller is presented in figure 1. It is worth to point out that the control of the rotor voltage, via the feedback gain, is taken as an image of the stator one; so, the DFIM control is carried out on the stator side.

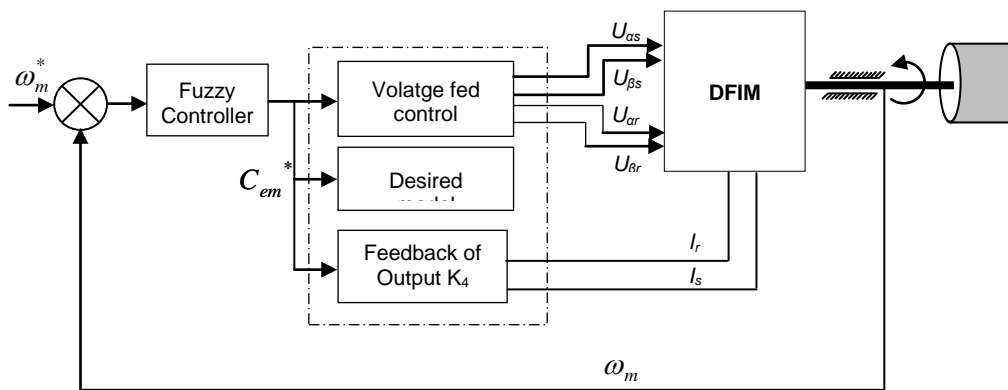

Figure 1. Proposed Structure with Fuzzy Speed Controller

3. Research Method

This section describes the PBC procedure. First of all, DFIM is set in Euler-Lagrange form. Next, the set-point of the PBC controller for tracking trajectories is designed. Finally, a quadratic Lyapunov function based on the system's energy is formulated.

3.1. DFIM Euler-Lagrange Modeling

The Euler-Lagrange equations for a conservative system [11-12] are given by:

$$\frac{d}{dt} \left[\frac{\partial L(q, \dot{q})}{\partial \dot{q}_i} \right] - \frac{\partial L(q, \dot{q})}{\partial q_i} = Q_i^e, \quad (i = 1, \dots, n) \quad (1)$$

where q is the generalized coordinates vector (q_i is the i^{th} component), L represents the Lagrangian function, and Q_i^e refers to the external forces acting on the system.

The Lagrangian function is described as:

$$L(q, \dot{q}) = T(q, \dot{q}) - V(q) \quad (2)$$

where $T(q, \dot{q})$ denotes the kinetic energy of the system and $V(q)$ is the potential energy.

The application of this approach to the DFIM leads to the Lagrangian model with fixed stator (α, β) coordinate system. Under the assumption of linear magnetic circuits and balanced operating conditions, the model is represented by two separate subsystems: the electrical one, described by (3), and the mechanical one described by (4).

$$D_e(P\theta_m)\dot{I}_e + W_1(P\theta_m)\omega_m I_e + R_e I_e = u^{\alpha\beta} \quad (3)$$

$$J\dot{\omega}_m = C_{em}(I_e, P\theta_m) - C_r - f\omega_m \quad (4)$$

where $\theta_m, P, C_{em}, C_r, J, \omega_m$ and f denote respectively the mechanical position, the number of DFIM pole pairs, the electromagnetic torque, the load torque, the rotor inertia, the mechanical speed and the friction parameter.

The $D_e(P\theta_m)$ matrix is described as follows:

$$D_e(P\theta_m) = \begin{bmatrix} L_s I_2 & L_{sr} e^{jP\theta_m} \\ L_{sr} e^{-jP\theta_m} & L_r I_2 \end{bmatrix} \quad (5)$$

where L_s, L_r , and L_{sr} are the stator self-inductance, the rotor self-inductance, and the mutual-inductance respectively.

The current, the voltage input, and the resistance vectors are defined by the following expressions (indexes s and r stand for stator and rotor axes respectively):

$$I_e = [I_{s\alpha}, I_{s\beta}, I_{r\alpha}, I_{r\beta}]^T; u^{\alpha\beta} = [u_{s\alpha}, u_{s\beta}, u_{r\alpha}, u_{r\beta}]^T; R_e = \text{diag}\{R_s I_2, R_r I_2\},$$

The matrix $W_1(P\theta_m)$ is expressed as [5]:

$$W_1(P\theta_m) = \begin{bmatrix} 0 & L_{sr} j P e^{jP\theta_m} \\ -L_{sr} j P e^{-jP\theta_m} & 0 \end{bmatrix} \quad (6)$$

where

$$e^{jP\theta_m} = \begin{bmatrix} \cos(P\theta_m) & -\sin(P\theta_m) \\ \sin(P\theta_m) & \cos(P\theta_m) \end{bmatrix} \text{ is the rotation matrix,}$$

$$j = \begin{bmatrix} 0 & -1 \\ 1 & 0 \end{bmatrix} \text{ is an anti-symmetric matrix.}$$

The electromagnetic torque generated by the electrical subsystem is defined as [5]:

$$C_{em}(I_e, P\theta_m) = \frac{1}{2} I_e^T W_1(P\theta_m) I_e \quad (7)$$

In order to formulate ideally the control problem, the following assumptions are made: all the states are measurable, all the parameters are known, and the load torque is smooth and a bounded function (its first derivative bounded and known). Moreover, the absolute value of the desired rotor flux is a constant value and denoted B .

3.2. Torque Tracking

The flux and currents are linked by the following expression:

$$\phi^{\alpha\beta} = D_e (P\theta_m) I_e \quad (8)$$

The corresponding rotor component is:

$$\phi_r^{\alpha\beta} = \begin{bmatrix} \phi_{r\alpha} \\ \phi_{r\beta} \end{bmatrix} = \|\phi_r^{\alpha\beta}\| \begin{bmatrix} \cos \rho \\ \sin \rho \end{bmatrix} \quad (9)$$

with $\|\phi_r^{\alpha\beta}\|$ is the rotor flux norm, and ρ is the angular position of the flux vector.

The speed of the flux vector in the α, β coordinate system is presented in [5, 13] as:

$$\dot{\rho} = \frac{R_r}{P \|\phi_r^{\alpha\beta}\|^2} C_{em} \quad (10)$$

Equation (9) in the desired mode is formulated as follows:

$$\phi_r^{\alpha\beta*} = \begin{bmatrix} \phi_{r\alpha}^* \\ \phi_{r\beta}^* \end{bmatrix} = B \begin{bmatrix} \cos \rho^* \\ \sin \rho^* \end{bmatrix} \quad (11)$$

where * denotes the desired value.

The desired speed and its derivative are expressed by the following equations:

$$\rho^* = \arctan \left(\frac{\phi_{r\alpha}^*}{\phi_{r\beta}^*} \right) \quad (12)$$

$$\dot{\rho}^* = \frac{R_r}{PB^2} C_{em}^* \quad (13)$$

It can be easily noticed that if :

$$\lim_{t \rightarrow \infty} \phi_r^{\alpha\beta} = \phi_r^{\alpha\beta*} \quad \text{then} \quad \lim_{t \rightarrow \infty} \|\phi_r^{\alpha\beta}\| = B \quad (14)$$

then equations (10) and (13) are equivalent, i.e.:

$$\lim_{t \rightarrow \infty} \frac{R_r}{P \|\phi_r^{\alpha\beta}\|^2} C_{em} = \frac{R_r}{PB^2} C_{em}^* \quad (15)$$

Therefore, the following important result is obtained:

$$\lim_{t \rightarrow \infty} C_{em} = C_{em}^* \quad (16)$$

As a conclusion we can state that if the control law of the inner loop insures the rotor flux regulation with an internal stability, the torque control is then achieved.

3.3. Desired State Values

Equation (3) can be reformulated as follows:

$$D_e(P\theta_m)\dot{I}_e + (W_1(P\theta_m)\omega_m + L(P\theta_m, \omega_m))I_e + (R_e - L(p\theta_m, \omega_m))I_e = u^{\alpha\beta} \quad (17)$$

with

$$L(P\theta_m, \omega_m) = \begin{bmatrix} 0 & 0 \\ L_{sr} jPe^{-jP\theta_m} & 0 \end{bmatrix} \omega_m \quad (18)$$

$$R_e - L(P\theta_m, \omega_m) = \begin{bmatrix} R_s I_2 & 0 \\ -L_{sr} jPe^{-jP\theta_m} \omega_m & R_r I_2 \end{bmatrix} \quad (19)$$

The electrical dynamic of the DFIM in the desired mode can be rewritten as:

$$D_e(P\theta_m)\dot{I}_e^* + (W_1(P\theta_m)\omega_m + L(P\theta_m, \omega_m))I_e^* + (R_e - L(p\theta_m, I_m))I_e^* = u^{\alpha\beta^*} \quad (20)$$

Equation (17) can be split into two equations:

$$L_s \dot{I}_s^* + L_{sr} e^{jP\theta_m} \dot{I}_r^* + L_{sr} jPe^{jP\theta_m} \omega_m I_r^* + R_s I_s^* = u_s^{\alpha\beta^*} \quad (21)$$

$$L_{sr} e^{-jP\theta_m} \dot{I}_s^* + L_r \dot{I}_r^* - L_{sr} jPe^{-jP\theta_m} \omega_m I_s^* + R_r I_r^* = u_r^{\alpha\beta^*} \quad (22)$$

The desired total flux as well as the currents of the DFIM are expressed respectively as follows [5, 13]:

$$\dot{\phi}_r^{\alpha\beta^*} = \frac{R_r C_{em}^*}{PB^2} j\phi_r^{\alpha\beta^*} \quad ; \quad \phi_r^{\alpha\beta^*}(0) = \begin{bmatrix} B \\ 0 \end{bmatrix} \quad (23)$$

$$I_r^* = \frac{u_r^{\alpha\beta^*}}{R_r} - \frac{C_{em}^*}{PB^2} j\phi_r^{\alpha\beta^*} \quad (24)$$

$$I_s^* = \left(\frac{L_r C_{em}^*}{L_{sr} PB^2} j + \frac{1}{L_{sr}} I_2 \right) e^{jP\theta_m} \phi_r^{\alpha\beta^*} \quad (25)$$

3.4. Error Dynamics

In order to shape the DFIM's total energy, we introduce an additional damping injection term K_I that improves the transient performance. Subtracting (17) from (20), the dynamic equation of the electrical subsystem state error becomes as follows:

$$D_e(P\theta_m)\dot{e}_e + (W_1(P\theta_m)\omega_m + L(P\theta_m, \omega_m))e_e + (R_e - L(p\theta_m, \omega_m) + K_1)e_e = 0 \quad (26)$$

where $e_e = [I_s^T, I_r^T]^T - [I_s^{*T}, I_r^{*T}]^T$

The new control signal input $u^{\alpha\beta}$ is defined as:

$$u^{\alpha\beta} = u^{\alpha\beta^*} - K_1 e_e \quad (27)$$

thus

$$K_1 = \text{diag} \{K_2, K_3\} \quad (28)$$

The quadratic equation and its derivative are expressed by:

$$\begin{aligned} V_1 &= \frac{1}{2} e_e^T D_e(P\theta_m) e_e \\ \dot{V}_1 &= -e_e^T (R_e - L(P\theta_m, \omega_m) + K_1)_{sym} e_e \end{aligned} \quad (29)$$

where the matrix $(R_e - L(P\theta_m, \omega_m) + K_1)_{sym}$ can be expanded into:

$$(R_e - L(P\theta_m, \omega_m) + K_1)_{sym} = \begin{bmatrix} (R_s + K_2)I_2 & \frac{1}{2} L_{sr} jP e^{jP\theta_m} \omega_m \\ -\frac{1}{2} L_{sr} jP e^{-jP\theta_m} \omega_m & (R_r + K_3)I_2 \end{bmatrix} \quad (30)$$

where the index 'sym' stands for symmetric matrix.

The damping injection term K_1 must guarantee that the latter matrix is positive. So, the following condition has to be satisfied:

$$(R_s + K_2)I_2 - \frac{1}{4(R_r + K_3)} (L_{sr} jP e^{jP\theta_m} \omega_m) (-L_{sr} jP e^{-jP\theta_m} \omega_m) > 0 \quad (31)$$

3.5. Voltage Fed Control

From equation (31), many conditions may be generated to ensure the positivity of equation (30):

– If the dynamic coefficient $(K_3 \ll R_r) > 0$, then equation (31) can be reduced as follows:

$$K_2 > \frac{L_{sr}^2}{4R_r} (P\omega_m)^2 \quad (32)$$

where the input signal is $u^{\alpha\beta} = u^{\alpha\beta*} - K_4 e_e$

with

$$K_4 = \text{diag} \left\{ K_2, \frac{K_2}{C} \right\}, (K_3 = K_2/C) \ll R_r \text{ and } C > 0 \quad (33)$$

– If the dynamic coefficient $(K_2 \ll R_s) > 0$, equation (31) can be reduced as follows:

$$K_3 > \frac{L_{sr}^2}{4R_s} (P\omega_m)^2 \quad (34)$$

where the input signal is $u^{\alpha\beta} = u^{\alpha\beta*} - K_5 e_e$

with

$$K_5 = \text{diag} \left\{ \frac{K_3}{C}, K_3 \right\}, (K_2 = K_3/C) \ll R_s \text{ and } C > 0. \quad (35)$$

Both condition (33) and (35) allow the system to be globally stable. In addition to that, the system defined by equations (3) and (4) will operate as desired, with a dynamic error (26) approaching zero.

3.6. Speed Tracking Using Fuzzy Logic Controller

The PBC of the speed tracking ensuring global stability in association with a convenient electromagnetic torque C_{em}^* is designed using a fuzzy logic controller. Figure 2 shows the block diagram of the system with the proposed fuzzy controller.

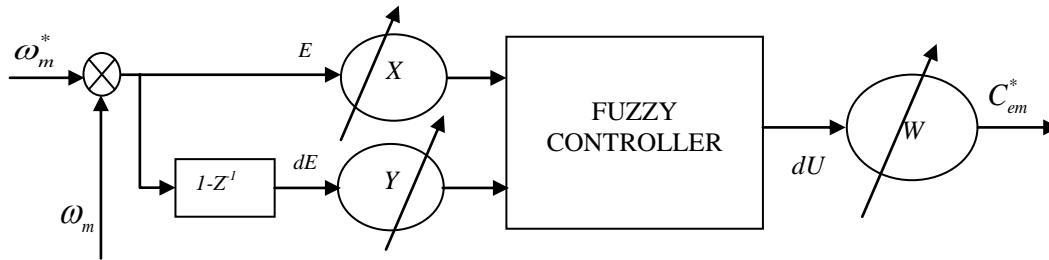

Figure 2. The Proposed Fuzzy Block Diagram

The controller input variables are the speed error E and its derivative dE . The fuzzy gain normalization are X , Y , W . The goal of the fuzzy logic controller is to set the electromagnetic torque to the desired value, by respecting the passivity optimal characteristics.

As for the design of the fuzzy logic controller, the input/output variables are quantified with suitable numbers; and triangular membership functions are selected for all variables, as shown in figure 3.

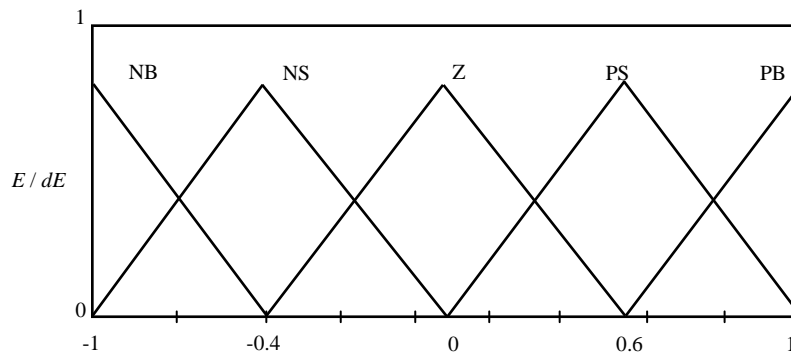

Figure 3. Triangular Membership Functions

To implement the fuzzy procedure, the Max-Min method of the inference algorithm is chosen in conjunction with the centroid method which is used in the defuzzification procedure. The linguistic control rules listed in table 1 are chosen according to the system experience as well as the dynamic signal variation of the speed.

Table 1. Linguistic Control Rules

<i>E</i>	<i>dE</i>	NB	NS	Z	PS	PB
NB		NB	NB	NS	NS	Z
NS		NB	NS	NS	Z	PS
Z		NS	NS	Z	PS	PS
PS		NS	Z	PS	PS	PB
PB		Z	PS	PS	PB	PB

The linguistic definitions of the membership functions are: NB (negative big), NS (negative small), Z (zero), PS (positive small) and PB (positive big). For illustration purpose, some of these rules are shown below:

Rule 1: if E is Z and dE is Z then C_{em}^* is Z

Rule 2: if E is PS and dE is Z then C_{em}^* is PS

Rule 3: if E is Z and dE is NS then C_{em}^* is NS

4. Results and Analysis

In order to show up the efficiency of the proposed solution, the PFLC is implemented on the DFIM using the Matlab/Simulink platform. The nominal physical parameters of the considered DFIM are: P= 1.5 kW, $V_s=220$ V, $V_r=12$ V, $R_s=4.85$ Ω , $R_r=3.805$ Ω , $L_s=0.274$ H, $L_r=0.274$ H $J=0.031$ kg.m², and $f=0.008$ Nm.s/rd.

The parameters used in the simulation are: the desired flux amplitude B=1.0253 Weber, and the desired angular speed $\omega_m^*=150$ rad/s. The fuzzy gain normalization are: X=1.5, Y=0.0052, W=1.

Figures 4, 5, 6 and 7 show respectively the PFLC results of the speed, the electromagnetic torque, the total flux, and stator current (phase A). Two speed references of 100 rad/s and 150 rad/s as well as a load torque varying from 0 Nm to 10 Nm are considered. The set of results illustrates the efficiency of the proposed technique for tracking desired trajectories with a complete rejection of the applied load torque.

Figure 4 shows that the speed tracking time response is very acceptable; it is less than 0.3 s. Also, the set-point transition from 100 rad/s to 150 rad/s is operated smoothly without any excessive peak. It is worth to point out that the regulated speed remains unaffected by the varying load torque which is applied in a form of a square signal as shown in figure 5.

As for the electromagnetic torque, figure 5 shows a good tracking despite the severe varying load torque.

Figure 6 shows that the PFLC ensures a constant total flux in a convenient time response.

Figure 7 shows the curve of the stator current (phase A). It is obvious that the DFIM responds naturally to the sinusoidal voltage inputs as well as to the load torque.

The current amplitude is perfectly consistent in accordance with the power and the stator voltage nominal values.

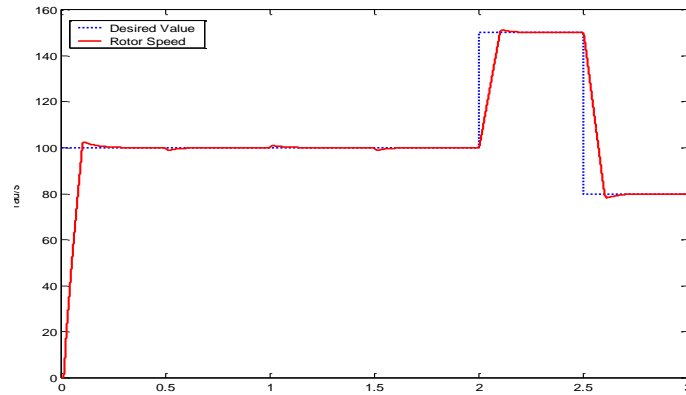

Figure 4. Regulated Speed

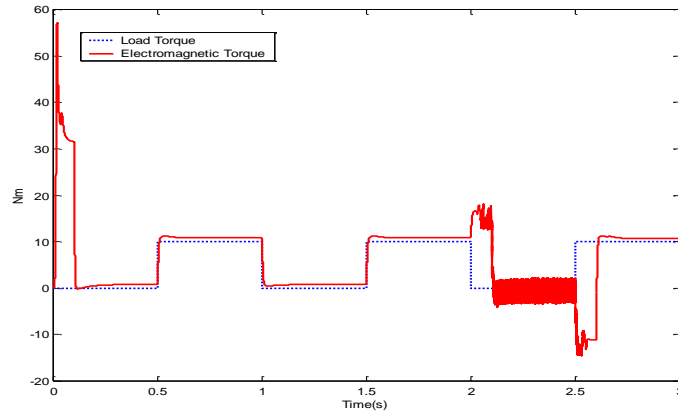

Figure 5. DFIM Torque

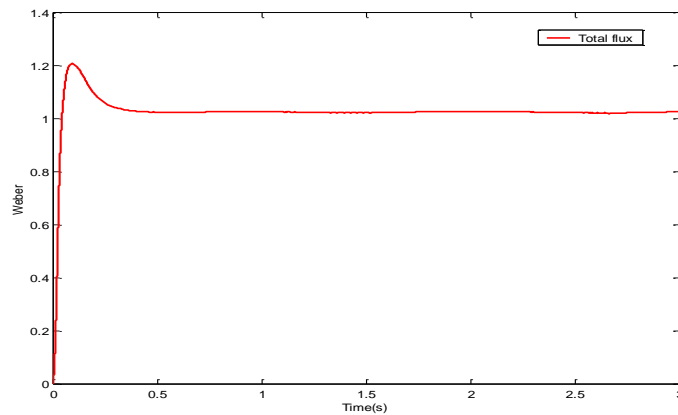

Figure 6. DFIM Total Flux

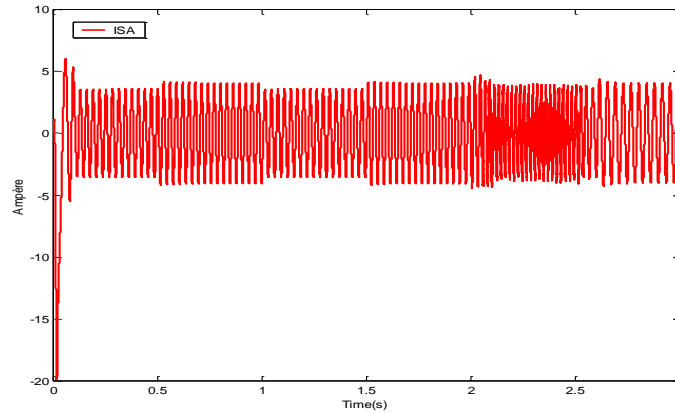

Figure 7. Stator Current

The PFLC robustness with respect of the DFIM parameter changes is verified by increasing the resistance values R_s and R_r with a rate of 75 %, and reducing the inductance values L_s and L_r with the rate of 25 %. The obtained results are shown in figures 8, 9, 10 and 11. Despite the DFIM physical parameter variations, speed response is unaffected, and the electromagnetic torque is still following the set-point with slight fluctuations. Total magnetic flux and stator current exhibit acceptable behaviors.

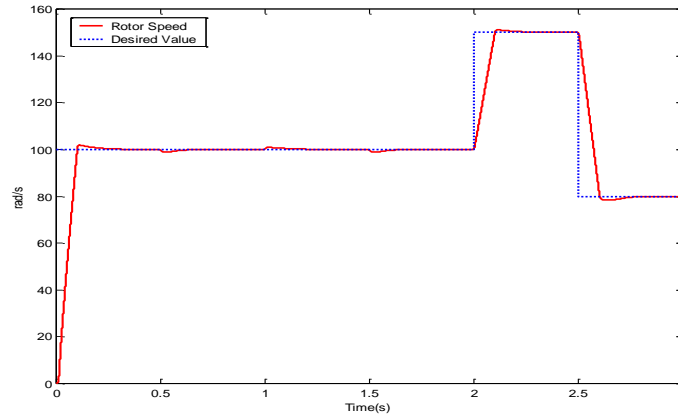

Figure 8. Regulated Speed in Robustness Mode

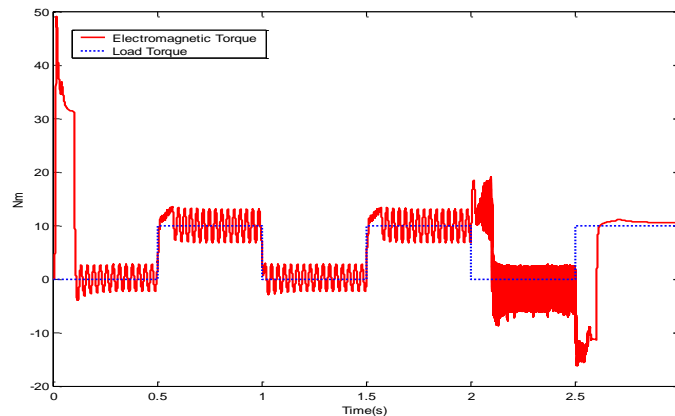

Figure 9. DFIM Torque in Robustness Mode

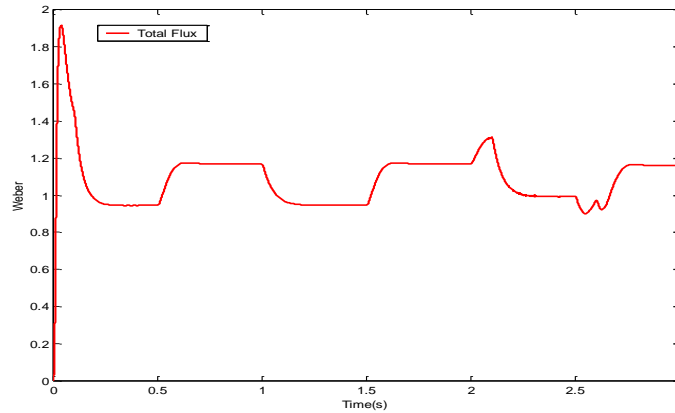

Figure 10. DFIM Total Flux in Robustness Mode

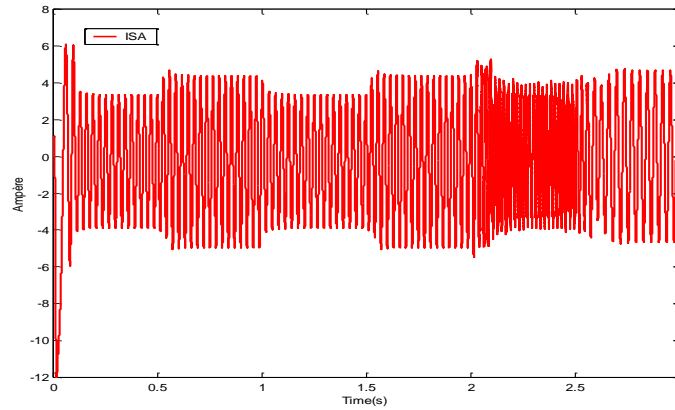

Figure 11. Stator Current in Robustness Mode

5. Comparison Results

The results of the proposed PFLC are compared to those presented in [2]. The speed time response presented in [2] (figure 12-b) is slightly less than the one of the PFLC (figure 12-a). However, the proposed controller shows a total rejection of the periodic load torque which is applied in a form of a square signal (figure 13-a), and presents the best tracking of the speed reference.

Moreover, the electromagnetic torque tracking presented in [2] (figure 13-b) is very disrupted, and exhibits a high peak at startup (almost 80 Nm). In contrast, the PFLC presents a satisfactory electromagnetic torque response; the startup peak is less than 30% comparing to the one presented in [2].

As for the stator current, the PFLC shows its efficiency compared to the adaptive fuzzy based field oriented control [2]. The PFLC current (figure 13-a) is unquestionably better.

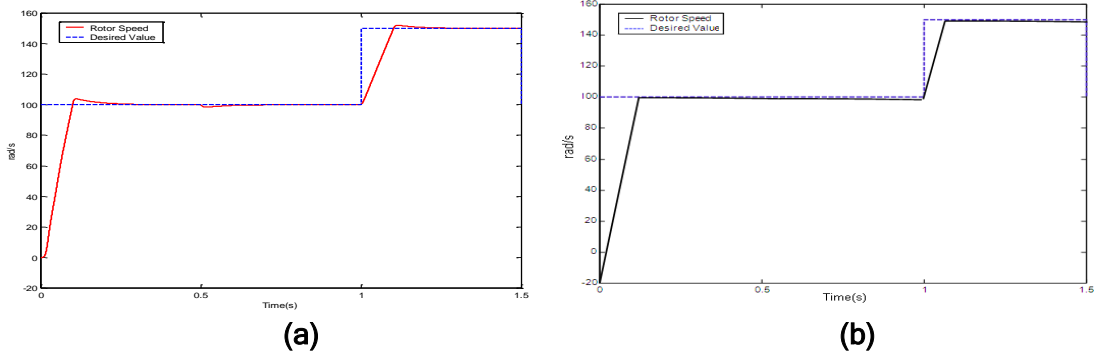

Figure 12. Regulated Speed: PFLC (a) vs [2] (b)

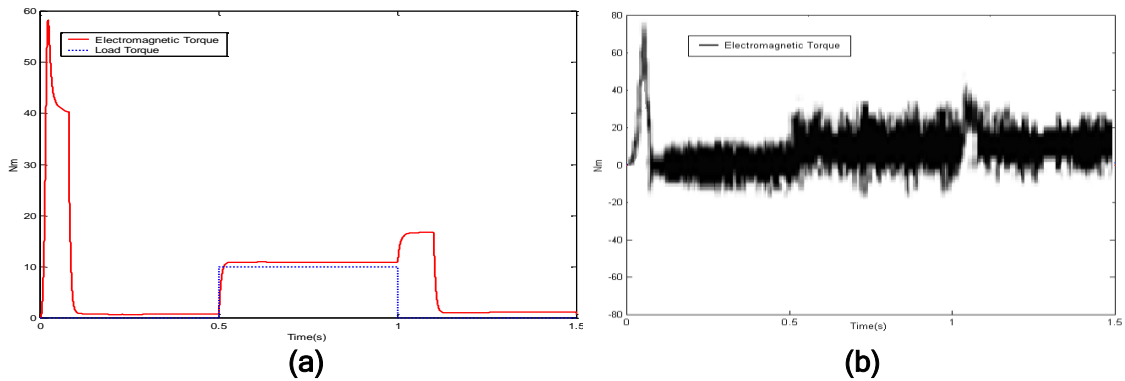

Figure 13. DFIM Torque: PFLC (a) vs [2] (b)

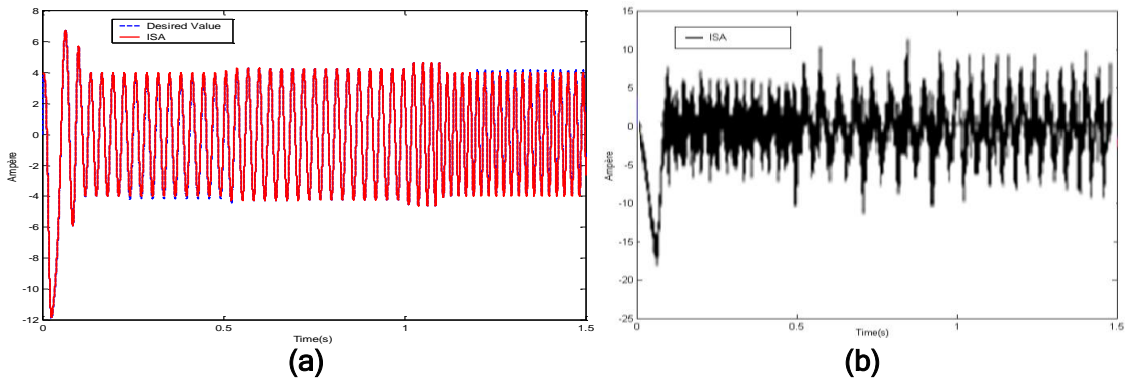

Figure 14. Stator Current: PFLC (a) vs [2] (b)

5. Conclusion

The speed-torque tracking controller for doubly fed induction machine associated with a fuzzy controller has been presented. The incorporation of the fuzzy logic part in the overall control leads to a noticeable quality in the electromagnetic torque with constant flux value, and reduced fluctuations in the time response. Compared to the Field Oriented Control (FOC) [2], which employs an adaptive fuzzy model, the proposed PFLC shows significant simulation results.

References

- [1] A. Dendouga, R. Abdessemed, M. L. Bendaas, and A. Chaiba, "Decoupled Active and Reactive Power Control of a Doubly-Fed Induction Generator (DFIG)" Proc. Mediterranean Conference on Control and Automation, Greece, 2007, pp. 1-5.
- [2] A.L. Nemours, and R. Abdessemed, "Control of Doubly Fed Induction Motor Drive (DFAM) Using Adaptive Takagi-Sugeno Fuzzy Model Based Controller", JEE, Vol. 4, N°2, 2004. pp. 95-101.
- [3] B. Carles, A. Doria-cerezo, and R. Ortega, "Power Flow Control of Doubly-Fed Induction Machine Coupled to a Flywheel", Proc. International Conf. on Control Application, Taiwan, Vol. 2, Issue 2-4, 2004, pp. 1645-1650.
- [4] S. Aïssi, L. Saidi, R. Abdessemed, and F. Ababsa, "Comparative Study of Passivity and RST Regulator Applied to Doubly Fed Induction Machine", KIEE journal, Vol. 4 N°4, 2009, pp. 521-526.
- [5] S. Aïssi, "Contribution au contrôle de la machine asynchrone double alimentée ", PhD Thesis, University of Batna, Algeria, 2010.
- [6] S. Aïssi, "Contrôle de la machine asynchrone, planifications des trajectoires et observation de flux ", Magister Thesis, University of Batna, Algeria, 2002.
- [7] G. Espinosa, and R. Ortega, "State observers unnecessary for induction motor control", System Control Letters, Vol. 23, N°5, 1994, pp. 315-323.
- [8] R. Ortega, P. J. Nicklasson and G. Espinosa "On speed control of induction motors," Automatica, Vol. 32, 1996, pp. 455-460.
- [9] A. Monroy, and L. Alvarez-Icaza, "Passivity Based Control of a DFIG Wind Turbine" Conf. American Control, Minnesota, USA, 2006, pp. 1050-1055.
- [10] L. Gökdere, W. Brice, and P. Nicklasson, "Correction to Passivity-based control of a class of Blondel-Park transformable machines" IEEE Trans. Aut. Control , Vol. AC-46, No 1, 2000, pp. 172-178.
- [11] M. W. Spong.; M. Vidyasagar "Robot dynamics and control", John Wiley and Sons, 1989.
- [12] J. Meisel. "Principal of electromechanical energy conversion", MCGRAW-HILL, 1969.
- [13] R. Ortega, A. Loria, P. J. Nicklasson, and H. Sira-Ramirez, "Passivity-based Control of Euler-Lagrange Systems", Communications and Control Engineering, Springer-Verlag, Berlin, 1998.

Authors



Salim Aïssi was born in Batna, Algeria in 1974. He received his Ph.D degree in electronic Engineering from Batna University, Algeria. Currently, he is Associate Professor at the department of electronics, Batna University, Algeria. His research interests are the control of induction machines, fuzzy control, and renewable energy.



Lamir Saidi was born in Batna, Algeria in 1968. He received his Engineering Master degree from University of Constantine, Algeria, in 1991 and the Ph.D. degree from Savoie University, France, in 1996. Currently, he is Associate Professor at the Department of Electronics, Batna University, Algeria. His interests include Digital Motion Control, Fuzzy control, Robust control Mechatronics, and Digital Signal Processing. He is member of CISE and RST.



Rachid Abdessemed was born in Batna, Algeria in 1951. He received the M.Sc. and Ph.D. degrees in Electrical Engineering from Kiev Polytechnic Institute, Kiev, Ukraine, in 1978 and 1982, respectively. He has been working for more than 29 years with the Department of Electrical Engineering, University of Batna, as a Professor. Currently, he is the Director of the Electrical Engineering Laboratory. His current area of research includes design and control of induction machines, reliability, magnetic bearing, and renewable energy



Fakhr-Eddine Ababsa received the PhD degree in Robotics from the University of Evry Val d'Essonne in 2002. He joined the IBISC-Complex System Laboratory in December 1999. Since 2004, he has been assistant Professor in Electrical and Computer Sciences at the University of Evry Val d'Essonne. His research interests are augmented reality, pattern recognition, motion tracking, sensor fusion and image processing.